

SPLIT-TYPE AIR CONDITIONERS

INDOOR UNIT

No. OBH958

SERVICE MANUAL

Models

MSZ-RZ25VU - E1, SC1

MSZ-RZ35VU - E1, SC1

MSZ-RZ50VU - E1, SC1

Outdoor unit service manual
MUZ-RZ•VU Series (OBH959)

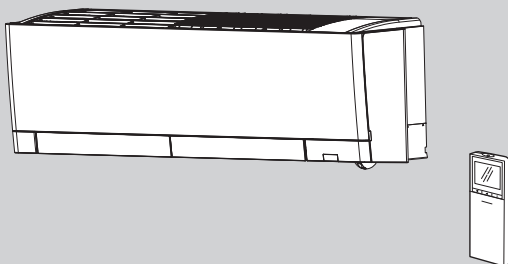

CONTENTS

1. TECHNICAL CHANGES	3
2. SERVICING PRECAUTIONS FOR UNITS USING REFRIGERANT R290	4
3. PART NAMES AND FUNCTIONS	11
4. SPECIFICATION	12
5. NOISE CRITERIA CURVE	13
6. OUTLINES AND DIMENSIONS	14
7. WIRING DIAGRAM	15
8. REFRIGERANT SYSTEM DIAGRAM	16
9. SERVICE FUNCTIONS	17
10. MICROPROCESSOR CONTROL	25
11. TROUBLESHOOTING	37
12. DISASSEMBLY INSTRUCTIONS	53

PARTS CATALOG (OBB958)

Use the specified refrigerant only

Never use any refrigerant other than that specified.

Doing so may cause a burst, an explosion, or fire when the unit is being used, serviced, or disposed of.

Correct refrigerant is specified in the manuals and on the spec labels provided with our products.

We will not be held responsible for mechanical failure, system malfunction, unit breakdown or accidents caused by failure to follow the instructions.

- R290 refrigerant is classified as class A3 in the safety group of ISO817 because it has low toxicity (class A) and higher flammability (class 3).
- It is a chemically stable compound of hydrogen and carbon.
Thus, it is not F-gas, but a fairly eco-friendly refrigerant with GWP of 3 or less.
- However, it is highly flammable and MUST be handled safely to prevent fire and explosion.

<Preparation before the repair service>

- Prepare the proper tools.
- Prepare the proper protectors.
- Provide adequate ventilation.
- After stopping the operation of the air conditioner, turn off the power-supply breaker and pull the power plug.
- Discharge the capacitor before the work involving the electric parts.

<Precautions during the repair service>

- Do not perform the work involving the electric parts with wet hands.
- Do not pour water into the electric parts.
- Do not touch the refrigerant.
- Do not touch the hot or cold areas in the refrigeration cycle.
- When the repair or the inspection of the circuit needs to be done without turning off the power, exercise great caution not to touch the live parts.

<End of life / disposal>

R290 RAC need to be treated according to WEEE. Be sure to observe the following.

- Do not dispose of R290 RAC with the household waste.
- According to the laws and ordinances of each country, hand in the product to a collection center for waste electrical or electronic equipment or directly Recycler authorized by manufacture.
- Check the following condition of the unit before transporting for disposal. If there is deemed to be a risk of leakage during transport, it needs to be empty the machine of refrigerant.
 - Strength
 - corrosion
 - refrigerant circuit status
 - securing the load
- Refrigerant must only be released, recovered and disposed properly by an authorized competent person.
 - Take the certification education of F-gas regulation if you want recover the R290 from unit before work for disposal.
- When you work for disposal, such as removing the unit and transporting to recycler, observe the safety requirement of R290 handling.
 - See the general education and transportation and installation part of professional education.

WARNING

- **When the refrigerant circuit has a leak, do not execute pump down with the compressor.**
- **When pumping down the refrigerant, stop the compressor before disconnecting the refrigerant pipes. The compressor may burst if air etc. get into it.**
- **When opening or closing the valve below freezing temperatures, refrigerant may spurt out from the gap between the valve stem and the valve body, resulting in injuries.**

1

TECHNICAL CHANGES

The following models are compatible with the outdoor units with low standby power control.
Connecting the following models to the MUZ-RZ-VUHZ series outdoor units enables the low standby power control.

MSZ-RZ25VU - E1, SC1

MSZ-RZ35VU - E1, SC1

MSZ-RZ50VU - E1, SC1

1. New model

Servicing precautions for units using refrigerant R290



This unit uses a flammable refrigerant.

If refrigerant leaks and comes in contact with fire or heating part, it will create harmful gas and there is risk of fire.

- Do not use means to accelerate the defrosting process or to clean, other than those recommended by the manufacturer.
 - The appliance shall be stored in a room without continuously operating ignition sources (for example: open flames, an operating gas appliance or an operating electric heater.)
 - Do not pierce or burn.
 - Be aware that refrigerants contain an odor.
 - Pipe-work shall be securely mounted and guarded from physical damage.
 - The installation of pipe-work shall be kept to a minimum.
 - Compliance with national gas regulations shall be observed.
 - Mechanical connections shall be accessible for maintenance purposes.
 - Keep any required ventilation openings clear of obstruction.
 - Servicing shall be performed only as recommended by the manufacturer.
 - Units should be installed stably so that the refrigerant piping does not vibrate or pulsate.
 - Protection devices, piping and fittings shall be protected as far as possible against adverse environmental effects, for example the danger of water collecting and freezing in relief pipes or the accumulation of dirt and debris.
 - Provision shall be made for expansion and contraction of long runs of piping.
 - Field-made refrigerant joints indoors shall be tightness tested. The test method shall have a sensitivity of 5 grams per year of refrigerant or better under a pressure of at least 0.25 times the maximum allowable pressure. No leak shall be detected.
 - Electrical components that can arc or spark, which are not considered ignition sources shall only be replaced with parts specified by the appliance manufacturer. Replacement with other parts may result in the ignition of refrigerant in the event of a leak.
 - The appliance shall be stored so as to prevent mechanical damage from occurring.
 - Maintenance, service and repair operations shall be performed by authorized technician with required qualification.
 - Follow EU and national regulations.
- With the revision of the F-Gas regulation, it is expected that operators will need to be certified for handling natural refrigerants as well as F-Gas.
- Always check the manual when performing work (Installation manual when installing, Service manual when servicing).
 - After installation, the installer should explain to the user that the refrigerant is an odorous flammable gas and that they should carefully read the installation booklet for instructions on how to use it.
 - Do not install in areas where smoke, gases, chemicals, etc. Do not install in a place filled with gas. The refrigerant sensor of the indoor unit may react and an error may be displayed.
 - When the breaker is on, pay attention to fan rotation. If the refrigerant sensor detects a refrigerant leak, the fan will start rotating automatically. There is a risk of injury from being caught in the fan.
 - When using the aerosol sprayer for interior work, finishing work or plugging wall holes, switch off the breaker and ventilate the room well. The refrigerant sensor may accidentally react to the spray gases, making the fan to start running and causing injury.

Safety Requirements and proper procedure of repair the R290 refrigerant circuit

If the proper work procedures and prohibitions are not followed, there is a possibility that the R290 may explode or cause a fire accident. In the worst case, there is a risk of loss of life.

[Safety Precautions]

- Make sure to provide sufficient space and ventilation.
- Make sure that there is no leakage of R290 refrigerant.
- Use a detector which is suitable for R290
(specifications that can detect properly and not become an ignition source).
- Do not place anything that could ignite in the protected area.
(Sparks from tool friction and static electricity can also be ignition sources.)
- R290 dissolves well in refrigeration oil and is highly flammable, so be sure to follow the instructions for proper refrigerant recovery.
- Use appropriate tools and equipment approved for R290 refrigerant.

[Prohibitions]

- When repairing the refrigerant parts, remove parts to be replaced by cutting, NOT by flame.
- Do not braze the pipe and unit which contain refrigerant.
- Do not smoke.
- Do not use the tool not to be approved with R290.

(1) Before starting the work, perform the following safety checks and preparations.

(a) Check and secure the work area.

- Make sure that the work area has sufficient space and is well ventilated or properly ventilated during working.
- There must be no ignition sources, spaces where refrigerant can stay, or openings that can flow into the building in the protected area of the outdoor unit.
- Only authorized personnel shall be allowed in the work area during operation. (Notes or impulse bar, etc. to prevent occupants from entering)

(b) Check for and eliminate ignition sources.

- Do not bring in ignition sources.
- Be careful of static electricity on work clothes, gloves, shoes and tools.
- Confirm that the outdoor unit is shut down and cut off the power supply to the outdoor unit.
- Discharge the condenser or capacitors in a way that will not cause sparks.
 - Make sure that LED on the outdoor controller circuit board goes out and wait for at least 1 minute.
 - If there is a refrigerant leak, never touch the electrical components while leak detection is being carried out because spark may occur even if LED1 goes out.

(c) Check the tools and equipment used.

- Make sure that the tools and equipment used are approved for R290 refrigerant.
- Confirm that R290 detectors, refrigerant recovery machines and vacuum pumps are construction and specification that will not be an ignition source for R290. (It must be sparkless, properly sealed, or intrinsically safe and R290 compliant).
- Appropriate protective equipment must be worn. Check for the presence of refrigerant.
- Verify that the R290 detector is working properly and carry it with you at all the times.
The detector should be set to 25% of LFL and calibrated for R290 refrigerant.
- Make sure that there is ;
 - no refrigerant in the work area and around the outdoor unit.
 - no leakage from the outdoor unit.
 - no refrigerant leakage inside the water circuit.
 - no flammable material stored in the work area.

- (d) Ensure that appropriate fire extinguishing equipment (e.g., fire extinguishers) is in place and ready for use.
- (e) Confirmation of work procedures and methods.
- Check the appropriate service manual of the manufacturer.
- (2) Completely remove the refrigerant following the step below.
- R290 dissolves into refrigerant oil better than R32/410A and is highly flammable, so be sure to follow the following procedure to remove the refrigerant in the refrigerant oil.
 - For appliances containing R290 refrigerants, refrigerants purging shall be achieved by breaking the vacuum in the system with oxygen-free nitrogen and continuing to fill until the working pressure is achieved, then venting to atmosphere, and finally pulling down to a vacuum. This process shall be repeated until no refrigerant is within the system. When the final oxygen-free nitrogen charge is used, the system shall be vented down to atmospheric pressure to enable work to take place. This operation is absolutely vital if brazing operations on the pipe-work are to take place.
- (a) Remove the refrigerant.
- Although R290 refrigerant is not F-gas, it should be properly recovered and disposed of according to the WEEE Directive. Please be sure to collect it in a dedicated recovery cylinder.
 - Be sure to use a refrigerant recovery unit and other equipment and tools that are compatible with R290.
 - If local regulations permit the release of R290, into the open air, it must be done safely.
 - Also, ATA models are sealed with odorized refrigerant, so be sure to check the surroundings thoroughly.
 - When releasing odorized refrigerant into the atmosphere, release it slowly and gradually.
- (b) Purge the refrigerant circuit with oxygen-free nitrogen for 5 min.
- Compressed air or oxygen shall not be used for purging refrigerant systems
- (c) Evacuate down the refrigerant circuit to a pressure of 30kPa absolute or lower
- The above pressures apply in an ambient temperature of 20 °C.
 - For other temperatures the pressure will need to be changed accordingly.
 - Be sure to use a vacuum pump that is compatible with R290 refrigerant.
 - Ensure that the outlet for the vacuum pump is not close to any potential ignition sources and that ventilation is available.
- (d) Purge the refrigerant circuit with nitrogen for 5 min.
- Compressed air or oxygen shall not be used for purging refrigerant systems.
- (3) Remove parts to be replaced by cutting, not by flame.
- Never attempt to remove parts by brazing.
 - Never use tools such as a hacksaw or mechanical cutting tools, they can cause sparking. Non-electric type is preferred.
 - * If the parts are brazed with refrigerant in them, an explosion or fire may occur, causing serious damage to people and buildings. In the worst case, there is a risk of loss of life.
 - Removed components that have been replaced, such as a compressor piping parts, keep ignition sources away from the refrigerator oil as a small amount of R290 is dissolved in it.
 - If the compressor is replaced, the entire outdoor unit will need to be replaced.
- (4) Brazing the new parts.
- Purge the braze point with nitrogen during the brazing procedure.
 - Do not braze the pipe and unit which contain refrigerant.
 - Before and during operation, be sure to check the area for refrigerant leaks with a suitable refrigerant detector.
 - The method and procedure are the same as for the R32 refrigerant model.
- (5) Carry out an Airtightness Test before charging with refrigerant.
- The method and procedure are the same as for the R32 refrigerant model.
- (6) Carry out vacuum drying before charging with refrigerant.
- Use the vacuum pump that is compatible with R290 refrigerant.
 - It is necessary to remove a sufficient level of moisture using a vacuum pump (0.5Torr or less).
 - The method and procedure are the same as for the R32 refrigerant model.
- (7) Charging the Refrigerant.
- Do not turn on the unit when charging the R290 refrigerant (must not add refrigerant while running)
 - Use a siphon cylinder to charge the refrigerant.
 - In addition to conventional charging procedures, the following requirements shall be followed
 - Ensure that contamination of different refrigerants does not occur when using charging equipment.
 - Hoses or lines shall be as short as possible to minimize the amount of refrigerant contained in them.
 - Cylinders shall be kept in an appropriate position according to the instructions.
 - Ensure that the refrigerating system is earthed prior to charging the system with refrigerant.
 - Label the system when charging is complete (if not already).
 - Extreme care shall be taken not to overfill the refrigerating system.
 - Prior to recharging the system, it shall be pressure-tested with the appropriate purging gas. The system shall be leak-tested on completion of charging but prior to commissioning. A follow up leak test shall be carried out prior to leaving the site.
 - The method and procedure are the same as for the R32 refrigerant model.
 - When refilling refrigerant in service, it is acceptable to seal in refrigerant without odorant.
- (8) Gas Leak Inspection
- Use a leak tester that can detect R290 refrigerant.
- (9) Reassemble sealed enclosures accurately.
- In case the sealed enclosures are opened, reassemble them accurately. Ex.) around elect box If seals are worn, replace them.

Tool

- Charge port
Standard for product: No (EN378, EN60335-2-40)
Charge port for R290: 7/16 UNF-20, clockwise (right screw)
- Cylinder port
Standard for cylinder: Depending on law by each country.
Connect charge port to left screw cylinder port

✕ : Prepare a new tool (Use the new tool as the tool exclusive for R290)

△ : Usable if the specifications on the left are satisfied

○ : Tools for other refrigerants can be used

Tool name	Specifications	Can other refrigerant tools be used?								
		R22	R410A	R32						
Gauge manifold	<ul style="list-style-type: none"> • Refrigerant charging is liquid-phase, so it is convenient to use a gauge manifold equipped with a sight window. • Be sure to use a gauge manifold compliant with R290 since the saturated temperature is different depending on the refrigerant. • You should select it that can be used in the operating range of -0.1 to 3.2 MPaG. • Port size : <table border="1"> <tr> <td></td> <td>R290</td> <td>R32 / R410A</td> </tr> <tr> <td>Manifold port size</td> <td>7/16 UNF 20 thread</td> <td>1/2 UNF 20 thread</td> </tr> </table> 		R290	R32 / R410A	Manifold port size	7/16 UNF 20 thread	1/2 UNF 20 thread	✕	✕	✕
	R290	R32 / R410A								
Manifold port size	7/16 UNF 20 thread	1/2 UNF 20 thread								
Charge hose	<ul style="list-style-type: none"> • Be sure to use a charge hose compliant with R290. • You should select it that can be used in the operating range of -0.1 to 3.2 MPaG. • Cap size: <table border="1"> <tr> <td></td> <td>R290</td> <td>R32 / R410A</td> </tr> <tr> <td>Cap size</td> <td>7/16 UNF 20 thread</td> <td>1/2 UNF 20 thread</td> </tr> </table> 		R290	R32 / R410A	Cap size	7/16 UNF 20 thread	1/2 UNF 20 thread	✕	✕	✕
	R290	R32 / R410A								
Cap size	7/16 UNF 20 thread	1/2 UNF 20 thread								
Charge valve	<ul style="list-style-type: none"> • The charge valve prevents gas escaping from the hose and air conditioner when removing the charge hose. • Be sure to use a charge valve compliant with R290. <p>Connection diameter: UNF 7/16-20 (1/4 flare) × UNF 7/16-20 (1/4 flare)</p>	✕	✕	✕						
Electronic weight scales	—	○	○	○						
Electric leak tester (gas leak detector)	<p>Before trying to use, confirm that the electronic leak tester can be used with the relevant refrigerant.</p> <p>* Do not use a combustion – based leak tester with R32 and R290.</p>	△	△	△						
Vacuum pump	<ul style="list-style-type: none"> • Be sure to use a vacuum pump compliant with R290 that has been specially designed and tested not to be an ignition source of itself. It is deeply better to use the vacuum pump that comply with explosion-proof standards such as ATEX and IECEx. • Additionally, if vacuum pump oil (mineral oil) is mixed into the refrigerant circuit of R290 or R32 or R410A, sludge will be generated and damage the air conditioner. * Use a reverse-flow prevention adapter. 	△	△	△						
Vacuum pump adapter	<p>When used for R290 or R32 or R410A, it is necessary to install an electromagnetic valve to prevent the flow of vacuum pump oil back into the charge hose. If the vacuum pump oil (mineral oil) is mixed into the refrigerant circuit of R290 or R32 or R410A, sludge will be generated and damage the air conditioner.</p>	○	○	○						
Pipe bender	—	○	○	○						
Cutter / Reamer	Do not use the tool that generate sparks due to tool friction such as a saw.	○	○	○						
Refrigerant cylinder	The cylinders are labeled according to the type of refrigerant.	✕	✕	✕						
Adapter for refrigerant cylinder	<p>Use an adapter that is appropriate to a connection of refrigerant cylinder and a charge port.</p> <ul style="list-style-type: none"> • Connection of refrigerant cylinder: depend on the refrigerant or the country • Charge port: UNF 1/2-20 (5/16 flare) for R32 or R410A UNF 7/16-20 (1/4 flare) for R290 	✕	✕	✕						
Refrigerant recovery equipment	<ul style="list-style-type: none"> • Be sure to use a recovery machine compliant with R290 that has been specially designed and tested not to be an ignition source of itself. It is deeply better to use the recovery machine that comply with explosion-proof standards such as ATEX and IECEx. 	△	△	△						
Refrigerant recovery cylinder	<p>The cylinders are labeled according to the type of refrigerant.</p> <p>Please separate the R290 with odor from the general R290.</p>	✕	✕	✕						
Electrical tools	<ul style="list-style-type: none"> • Do not use the electrical tools that generate sparks due to tool friction such as an electrical cutter, an electrical saw and a grinder. • In case of use the electrical tools that drive with motor such as an electrical driver, be sure to use one with brush-less motor. 	△	△	△						
FAN	<ul style="list-style-type: none"> • Be sure to use a fan compliant with R290 that has been specially designed and tested not to be an ignition source of itself. It is deeply better to use the fan that comply with explosion-proof standards such as ATEX and IECEx. 	△	△	△						
Flaring tool	Do not use the electrical tools that generate sparks due to tool friction.	△	△	△						

Properties of refrigerant

(1) Pressure

As shown in the following table, at the same refrigerant temperature, the saturated vapor pressure of R290 is lower than that of R32 and about as same as that of R22. The design pressure of RAC is 2.24MPa(G) , it is same level as R22.

(2) Flammability

- As shown in the following table, R290 ignites with much less concentration and energy than R32.
- In addition, it burns explosively unlike R32.
- In other words, when handling the products and cylinders containing the R290, there is a higher probability of causing a larger explosion or fire than the R32. Therefore, stricter safety measures are required than R32 refrigerant.

(3) R290 concentration

When the R290 is leaking from the product, it tends to concentrate to lower area as well as R32 because it is heavier than air. It is necessary to take the safety measures for R290 leakage in consideration of this characteristic.

- the openings, such as a following, for letting out the refrigerant gas should be provided at the bottom.
ex. - a gap between the bottom of the door and the ground of the room.
 - A louver for ventilation in a room or balcony
- Do not install the R290 products or cylinders in or around underground or hollow.
- When checking for leaks with a detector, check not only the product but also the bottom of the surrounding area.
- Ignition source should be far enough away from the product and the ground.

(4) Smell

- The propane used as a refrigerant for the R290ATA has an odor.
- The odorant is THT, which gives it a smell similar to city gas. (THT: Tetrahydrothiophene).
- In other words, it is possible to notice by the odor whether or not the refrigerant is leaking, so you should ventilate if you notice.

WHAT TO DO in case of leak

Ventilation

- Open a window or balcony
- Open door/s between rooms

Electricity (as it may cause sparks)

- Do not turn on or off lamps
- Do not plug in or out sockets or other devices.
- Do not turn off air conditioner

* As same as the MFZ, the indoor unit is equipped with a refrigerant leak sensor.

When a leak is detected, the indoor fan rotates to agitate the air in the room and operation to reduce the concentration of R290.

(5) Condition to ignite to R290

- R290 leakage
- R290 concentration (1.8%-9.5%)
- Ignition source

Only when 3 issues are satisfied, ignition happens.

If even one issue is NOT satisfied, ignition does NOT happen.

The important point is to prevent these 3 issues when installing.

Safety countermeasure

Although R290 is categorised to higher flammability, ignition condition can be removed by following 3 rules which are same as R32 unit.

(1) Do not leak refrigerant

- Do not give strong impact, vibration or heat that would damage the R290 unit.
- Should not release refrigerant to air.
- Use a recovery machine certified for R290 refrigerant if it need to removing the refrigerant from the unit. *1
- If it is permissible to release the refrigerant into the open air, it must be done safely.
 - you do this by directing the refrigerant to a safe area in the open air that is well ventilated.
 - Between the machine and the discharge point, an oil separator should be mounted to take care of any oil droplets.
- Check with the detector whether the unit's refrigerant is leaking. *2
 - While the worker are handling R290 refrigerant and unit, it should be used a portable gas detector.(including when transport and storage)
 - Be sure to use the leak detector compatible to R290 refrigerant.
 - Detector can be clipped to clothing or placed on the floor within the working area.
 - It should be switched on for the duration of the work and set to alarm at 25% of the LFL, to alert staff members of imminent flammable concentration.
 - Technicians can be alerted whenever an inadvertent release of flammable refrigerant occurs.
 - Technicians are capable of immediately acting on the relevant emergency procedures.

(2) Ventilating when handling the R290 unit or cylinder.

<Common situation>

- Opening the door or window
- Using a fan compliant with R290 Refrigerant.

<Transportation>

- In case VAN type cars are unavoidable for delivery, forced ventilation need to be mandatory. *3
 - Use ventilated cars like below images
 - Normal VAN with fresh outside air intake mode + MAX fan volume operation are mandatory.
 - Better if fire extinguishers and leak detectors are available

<Installation, stored>

- Do not install the R290 units or cylinders in or around underground, hollow, and enclosed space.
- In case of installing it in the enclosed space, be sure to comply with the following.
 - Install the unit to enough space depending on refrigerant amount.
 - or
 - the openings for letting out the refrigerant gas are provided at the bottom.

NOTE:

*1 Qualifications are required for work on refrigerants and refrigerant circuits, such as repairing refrigerant circuits and recovering refrigerants.

Only workers who have specialized knowledge and are certified by the MEU branch can do it.

*2 The detector itself may be the source of ignition. Be sure to use a detector that is compatible with the R290 refrigerant.

*3 Just opening the window is not enough to ventilate the refrigerant. Do not place the unit in such a way as to block the ventilation openings.

- (3) Keeping ignition source away from the unit.
- The following are the ignition sources in R290.
 - Keep them, away from around the R290 unit.
 - Examples of ignition source:
Open flames, electrical equipment, sockets, lamps, light switches, residential electrical wiring, sparking tools, objects with a surface temperature of 370°C or higher, etc.
 - Sparks due to tool friction also be a source of ignition.
Work that sparks should be done away from the unit.
 - Be sure to use a tool compliant with R290.
 - Do not install unit during turning on electricity.
Turning off electricity and checking by tester before installing R290 unit.
 - Static electricity is also an ignition source !!
Anti-static measures (anti-static and static electricity elimination) should be taken.

[Introduction of anti-static methods]

- Touch a grounded metal object once in a while to remove any charge from your body.
- Touching a water tap works extremely well.
- Use anti static wrist strap equipment to avoid potential differences between you and the appliances serviced.
* But attention: These wrist straps are not always grounded
- Wear work clothes, gloves and shoes with antistatic measures.
- Do not brazing the pipe and unit which contain refrigerant. Before brazing, refrigerant should be removed.
- Be sure to follow the additional steps below in accordance with EN60335-2-40 after recovering the R290 refrigerant.
 - Purge the refrigerant circuit with inert gas for 5 min.
 - Evacuate the refrigerant circuit.
 - Purge the refrigerant circuit again with inert gas for 5 min. (Inert gas is for example oxygen-free nitrogen)
- When repairing the refrigerant parts, remove parts to be replaced by cutting with pipe cutter, NOT by flame nor by electric saw, etc.

Safety Requirements

- (1) Before starting the work, perform the following safety checks and preparations.
- (a) Check the tools and equipment used.
- Appropriate protective equipment must be worn.
 - Verify that the R290 detector is working properly and carry it with you at all the times.
The detector should be set to 25% of LFL and calibrated for R290 refrigerant.
 - Make sure that there is
 - no refrigerant in the work area and around the outdoor unit.
 - no leakage from the outdoor unit.
 - no refrigerant leakage inside the water circuit.
 - no flammable material stored in the work area.
- (b) Check and secure the work area.
- Make sure that the work area has sufficient space and is well ventilated or properly ventilated during working.
 - There must be no ignition sources, spaces where refrigerant can stay, or openings that can flow into the building in the protected area of the outdoor unit.
 - Only authorized personnel shall be allowed in the work area during operation. (Notes or impulse bar, etc. to prevent occupants from entering)
- (c) Check for and eliminate ignition sources.
- Do not bring in ignition sources.
 - Be careful of static electricity on work clothes and tools.
 - Confirm that the outdoor unit is shut down and cut off the power supply to the outdoor unit.
 - Discharge the condenser or capacitors in a way that will not cause sparks.
 - Make sure that LED on the outdoor controller circuit board goes out and wait for at least 1 minute.
 - If there is a refrigerant leak, never touch the electrical components while leak detection is being carried out because spark may occur even if LED1 goes out.
- (d) Ensure that appropriate fire extinguishing equipment (e.g., fire extinguishers) is in place and ready for use.
- (e) Confirmation of work procedures and methods.
- (2) During the work for electrical components, perform the following safety precaution.
- Repair and maintenance to electrical components shall include initial safety checks.
 - Make sure, in a way that will not cause sparks, that the condenser or capacitors is discharged.
 - Make sure that electrical components are grounded.
 - In case of repairing the sealed components that include ignition source, you must disconnect All electrical supplies from the unit. If it is absolutely necessary to have an electrical supply to equipment during servicing, be sure to locate a permanently operating form of leak detection at the most critical point.
 - Ensure that seals or sealing materials have not degraded to the point that they no longer serve the purpose of preventing the ingress of flammable atmospheres. In case it have degraded, Replace them new parts in accordance with the manufacturer's specifications.
 - Replace components only with parts specified by the manufacturer since other parts may result in the ignition of refrigerant in the atmosphere from a leak.

Basic work procedures are the same as those for conventional units using refrigerant R32 or R410A. However, pay careful attention to the following points.

1. Information on servicing
 - (1) Checks on the Area
Prior to beginning work on systems containing flammable refrigerants, safety checks are necessary to ensure that the risk of ignition is minimized.
 - (2) Work Procedure
Work shall be undertaken under a controlled procedure so as to minimize the risk of a flammable gas or vapor being present while the work is being performed.
 - (3) General Work Area
All maintenance staff and others working in the local area shall be instructed on the nature of work being carried out. Work in confined spaces shall be avoided. The area around the workspace shall be sectioned off. Ensure that the conditions within the area have been made safe by control of flammable material.
 - (4) Checking for Presence of Refrigerant
The area shall be checked with an appropriate refrigerant detector prior to and during work, to ensure the technician is aware of potentially toxic or flammable atmospheres. Ensure that the leak detection equipment being used is suitable for use with all applicable refrigerants, i.e. non-sparking, adequately sealed or intrinsically safe.
 - (5) Presence of Fire Extinguisher
If any hot work is to be conducted on the refrigeration equipment or any associated parts, appropriate fire extinguishing equipment shall be available to hand. Have a dry powder or CO2 fire extinguisher adjacent to the charging area.
 - (6) No Ignition Sources
No person carrying out work in relation to a refrigeration system which involves exposing any pipe work shall use any sources of ignition in such a manner that it may lead to the risk of fire or explosion. All possible ignition sources, including cigarette smoking, should be kept sufficiently far away from the site of installation, repairing, removing and disposal, during which refrigerant can possibly be released to the surrounding space. Prior to work taking place, the area around the equipment is to be surveyed to make sure that there are no flammable hazards or ignition risks. "No Smoking" signs shall be displayed.
 - (7) Ventilated Area
Ensure that the area is in the open or that it is adequately ventilated before breaking into the system or conducting any hot work. A degree of ventilation shall continue during the period that the work is carried out. The ventilation should safely disperse any released refrigerant and preferably expel it externally into the atmosphere.
 - (8) Checks on the Refrigeration Equipment
Where electrical components are being changed, they shall be fit for the purpose and to the correct specification. At all times the manufacturer's maintenance and service guidelines shall be followed. If in doubt, consult the manufacturer's technical department for assistance.
The following checks shall be applied to installations using flammable refrigerants:
 - The charge size is in accordance with the room size within which the refrigerant containing parts are installed.
 - The ventilation machinery and outlets are operating adequately and are not obstructed.
 - If an indirect refrigerating circuit is being used, the secondary circuit shall be checked for the presence of refrigerant.
 - Marking to the equipment continues to be visible and legible. Markings and signs that are illegible shall be corrected.
 - Refrigeration pipe or components are installed in a position where they are unlikely to be exposed to any substance which may corrode refrigerant containing components, unless the components are constructed of materials which are inherently resistant to being corroded or are suitably protected against being corroded.
 - (9) Checks on Electrical Devices
Repair and maintenance to electrical components shall include initial safety checks and component inspection procedures. If a fault exists that could compromise safety, then no electrical supply shall be connected to the circuit until it is satisfactorily dealt with. If the fault cannot be corrected immediately but it is necessary to continue operation, an adequate temporary solution shall be used. This shall be reported to the owner of the equipment so all parties are advised.
Initial safety checks shall include that:
 - capacitors are discharged: this shall be done in a safe manner to avoid possibility of sparking;
 - no live electrical components and wiring are exposed while charging, recovering or purging the system;
 - there is continuity of earth bonding
2. Sealed electrical components
Sealed electrical components shall not be repaired.
3. Cabling
Check that cabling will not be subject to wear, corrosion, excessive pressure, vibration, sharp edges or any other adverse environmental effects. The check shall also take into account the effects of aging or continual vibration from sources such as compressors or fans.
4. Detection of Flammable Refrigerants
Under no circumstances shall potential sources of ignition be used in the searching for or detection of refrigerant leaks. A halide torch (or any other detector using a naked flame) shall not be used.
5. Leak Detection Methods
Electronic leak detectors may be used to detect refrigerant leaks but, in the case of flammable refrigerants, the sensitivity may not be adequate, or may need recalibration. (Detection equipment shall be calibrated in a refrigerant-free area.) Ensure that the detector is not a potential source of ignition and is suitable for the refrigerant used. Leak detection equipment shall be set at a percentage of the LFL of the refrigerant and shall be calibrated to the refrigerant employed, and the appropriate percentage of gas (25 % maximum) is confirmed.
Leak detection fluids are suitable for use with most refrigerants but the use of detergents containing chlorine shall be avoided as the chlorine may react with the refrigerant and corrode the copper pipe-work.
If a leak is suspected, all naked flames shall be removed/extinguished.
If a leakage of refrigerant is found which requires brazing, all of the refrigerant shall be recovered from the system, or isolated (by means of shut off valves) in a part of the system remote from the leak. For appliances containing flammable refrigerants, oxygen free nitrogen (OFN) shall then be purged through the system both before and during the brazing process.
6. Removal and Evacuation
When breaking into the refrigerant circuit to make repairs - or for any other purpose conventional procedures shall be used. However, for flammable refrigerants it is important that best practice is followed since flammability is a consideration. The following procedure shall be adhered to:
 - remove refrigerant
 - purge the circuit with inert gas
 - evacuate
 - purge again with inert gas
 - open the circuit by cutting or brazing.The refrigerant charge shall be recovered into the correct recovery cylinders. For appliances containing flammable refrigerants, the system shall be "flushed" with OFN to render the unit safe. This process may need to be repeated several times. Compressed air or oxygen shall not be used for purging refrigerant systems. For appliances containing flammable refrigerants, flushing shall be achieved by breaking the vacuum in the system with OFN and continuing to fill until the working pressure is achieved, then venting to atmosphere, and finally pulling down to a vacuum. This process shall be repeated until no refrigerant is within the system. When the final OFN charge is used, the system shall be vented down to atmospheric pressure to enable work to take place. This operation is absolutely vital if brazing operations on the pipe-work are to take place.
Ensure that the outlet for the vacuum pump is not close to any ignition sources and that ventilation is available.

7. Charging Procedures

In addition to conventional charging procedures, the following requirements shall be followed:

- Ensure that contamination of different refrigerants does not occur when using charging equipment. Hoses or lines shall be as short as possible to minimize the amount of refrigerant contained in them.
- Cylinders shall be kept upright.
- Ensure that the refrigeration system is earthed prior to charging the system with refrigerant.
- Label the system when charging is complete (if not already).
- Extreme care shall be taken not to overfill the refrigeration system.

Prior to recharging the system, it shall be pressure-tested with the appropriate purging gas. The system shall be leak-tested on completion of charging but prior to commissioning. A follow up leak test shall be carried out prior to leaving the site.

8. Decommissioning

Before carrying out this procedure, it is essential that the technician is completely familiar with the equipment and all its detail. It is recommended good practice that all refrigerants are recovered safely. Prior to the task being carried out, an oil and refrigerant sample shall be taken in case analysis is required prior to reuse of reclaimed refrigerant. It is essential that electrical power is available before the task is commenced.

(1) Become familiar with the equipment and its operation.

(2) Isolate system electrically.

(3) Before attempting the procedure, ensure that:

- mechanical handling equipment is available, if required, for handling refrigerant cylinders;
- all personal protective equipment is available and being used correctly;
- the recovery process is supervised at all times by a competent person;
- recovery equipment and cylinders conform to the appropriate standards.

(4) Pump down refrigerant system, if possible.

(5) If a vacuum is not possible, make a manifold so that refrigerant can be removed from various parts of the system.

(6) Make sure that cylinder is situated on the scales before recovery takes place.

(7) Start the recovery machine and operate in accordance with manufacturer's instructions.

(8) Do not overfill cylinders. (no more than 80 % volume liquid charge).

(9) Do not exceed the maximum working pressure of the cylinder, even temporarily.

(10) When the cylinders have been filled correctly and the process completed, make sure that the cylinders and the equipment are removed from site promptly and all isolation valves on the equipment are closed off.

(11) Recovered refrigerant shall not be charged into another refrigeration system unless it has been cleaned and checked.

9. Labeling

Equipment shall be labeled stating that it has been de-commissioned and emptied of refrigerant. The label shall be dated and signed. For appliances containing flammable refrigerants, ensure that there are labels on the equipment stating the equipment contains flammable refrigerant.

10. Recovery

When removing refrigerant from a system, either for servicing or decommissioning, it is recommended good practice that all refrigerants are removed safely.

When transferring refrigerant into cylinders, ensure that only appropriate refrigerant recovery cylinders are employed. Ensure that the correct number of cylinders for holding the total system charge are available. All cylinders to be used are designated for the recovered refrigerant and labeled for that refrigerant (i.e. special cylinders for the recovery of refrigerant). Cylinders shall be complete with pressure-relief valve and associated shut-off valves in good working order. Empty recovery cylinders are evacuated and, if possible, cooled before recovery occurs.

The recovery equipment shall be in good working order with a set of instructions concerning the equipment that is at hand and shall be suitable for the recovery of all appropriate refrigerants including, when applicable, flammable refrigerants. In addition, a set of calibrated weighing scales shall be available and in good working order. Hoses shall be complete with leak-free disconnect couplings and in good condition. Before using the recovery machine, check that it is in satisfactory working order, has been properly maintained and that any associated electrical components are sealed to prevent ignition in the event of a refrigerant release. Consult manufacturer if in doubt.

The recovered refrigerant shall be returned to the refrigerant supplier in the correct recovery cylinder, and the relevant waste transfer note arranged. Do not mix refrigerants in recovery units and especially not in cylinders.

If compressors or compressor oils are to be removed, ensure that they have been evacuated to an acceptable level to make certain that flammable refrigerant does not remain within the lubricant. The evacuation process shall be carried out prior to returning the compressor to the suppliers. Only electric heating to the compressor body shall be employed to accelerate this process. When oil is drained from a system, it shall be carried out safely.

3

PART NAMES AND FUNCTIONS

MSZ-RZ25VU MSZ-RZ35VU MSZ-RZ50VU

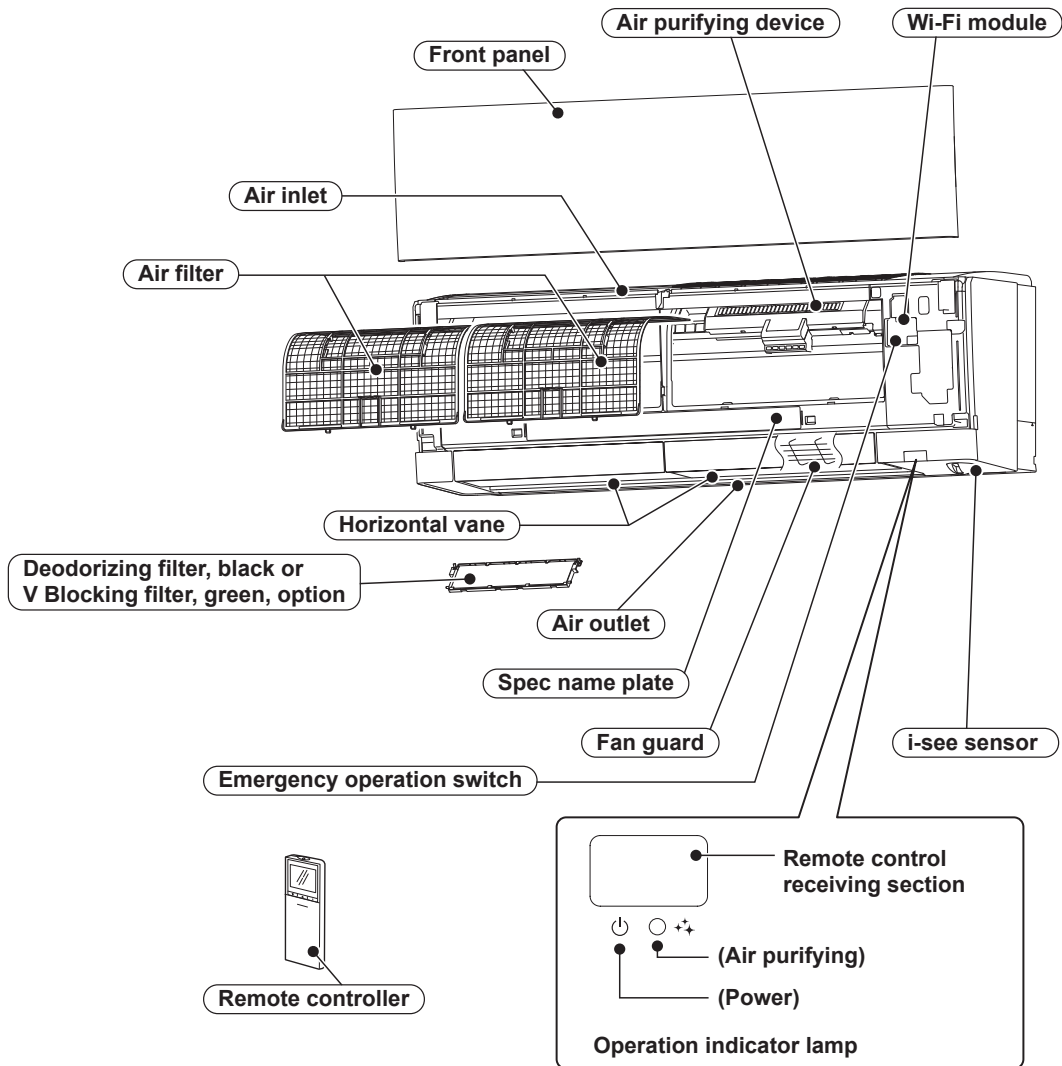

ACCESSORIES

Model	All models
(1) Installation plate	1
(2) Installation plate fixing screw 4 × 25 mm	5
(3) Wireless remote controller	1
(4) Felt tape (For left or left-rear piping)	1
(5) Battery (AAA) for remote controller	2
(6) Air cleaning filter (Deodorizing filter, black)	1
(7) Air purifying device	1

4

SPECIFICATION

Indoor model			MSZ-RZ25VU	MSZ-RZ35VU	MSZ-RZ50VU		
Power supply			Single phase 230 V, 50 Hz				
Electrical data	Power input *1	Cooling	W	13	21	29	
		Heating	W	21	26	41	
	Running current *1	Cooling	A	0.14	0.21	0.28	
		Heating	A	0.21	0.25	0.37	
Fan motor	Model		RC0J40-SA				
	Current *1	Cooling	A	0.14	0.21	0.28	
		Heating	A	0.21	0.25	0.37	
Dimensions W × H × D			mm				
Weight	- [E]		kg	14.4	14.4	14.6	
	- [SC]		kg	14.5	14.5	14.6	
Special remarks	Air direction		5				
	Airflow	Cooling	Super High	m ³ /h	702	846	972
			High		630	690	786
			Med.		540		666
			Low		390	414	570
			Silent		306		468
		Heating	Super High	m ³ /h	846	918	1092
			High		702		882
			Med.		570		750
			Low		468		642
			Silent		306		468
	Sound level	Cooling	Super High	dB(A)	42	43	45
			High		36		39
			Med.		29		34
			Low		23	24	30
			Silent		19		26
		Heating	Super High	dB(A)	41	42	46
			High		36		41
			Med.		30		37
			Low		25		32
			Silent		19		25
	Fan speed	Cooling	Super High	rpm	800	920	1,020
			High		740	790	870
			Med.		660		770
Low			530		550	690	
Silent			450		600		
Heating		Super High	rpm	920	980	1,120	
		High		800		950	
		Med.		690		840	
		Low		600		750	
		Silent		450		600	
Fan speed regulator			5				
Remote controller model	- [E]		SH24V				
	- [SC]		SH24W				

NOTE: Test conditions are based on ISO 5151.

Cooling: Indoor Dry-bulb temperature 27°C Wet-bulb temperature 19°C

Outdoor Dry-bulb temperature 35°C

Heating: Indoor Dry-bulb temperature 20°C

Outdoor Dry-bulb temperature 7°C Wet-bulb temperature 6°C

*1 Measured under rated operating frequency.

Specifications and rating conditions of main electric parts

Fuse	(F11)	T3.15AL250 V
Horizontal vane motor	(MV1)	12 V DC
Vertical vane motor	(MV2)	12 V DC
i-see SENSOR MOTOR	(MT)	12 V DC
Varistor	(NR11)	470 V
Terminal block	(TB)	4P

5

NOISE CRITERIA CURVE

MSZ-RZ25VU

FAN SPEED	FUNCTION	SPL(dB(A))	LINE
Super High	COOLING	42	●—●
	HEATING	41	○—○

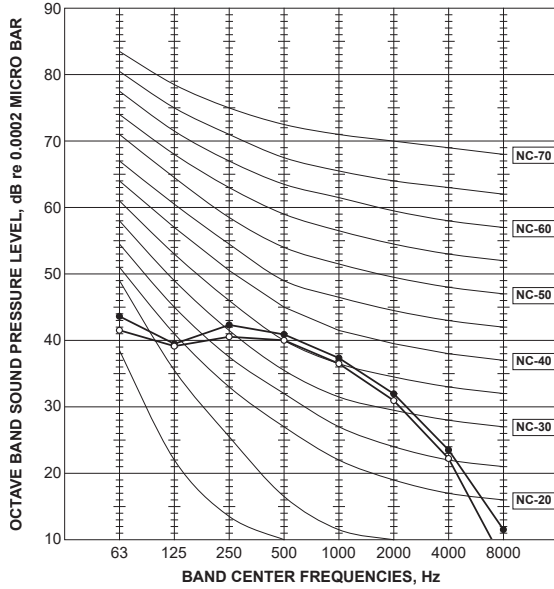

MSZ-RZ35VU

FAN SPEED	FUNCTION	SPL(dB(A))	LINE
Super High	COOLING	43	●—●
	HEATING	42	○—○

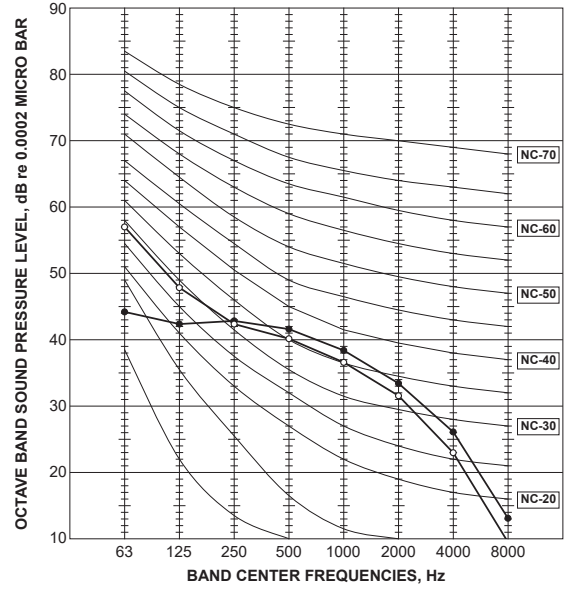

MSZ-RZ50VU

FAN SPEED	FUNCTION	SPL(dB(A))	LINE
Super High	COOLING	45	●—●
	HEATING	46	○—○

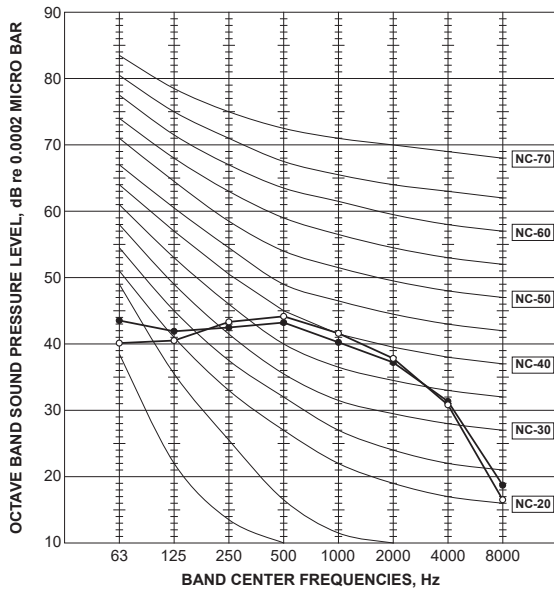

Test conditions

Cooling: Dry-bulb temperature 27 °C

Wet-bulb temperature 19 °C

Heating: Dry-bulb temperature 20 °C

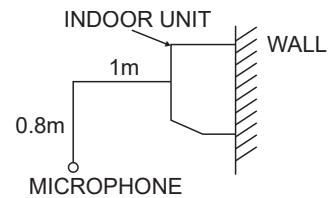

6

OUTLINES AND DIMENSIONS

MSZ-RZ25VU MSZ-RZ35VU MSZ-RZ50VU

Unit: mm

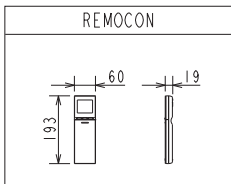
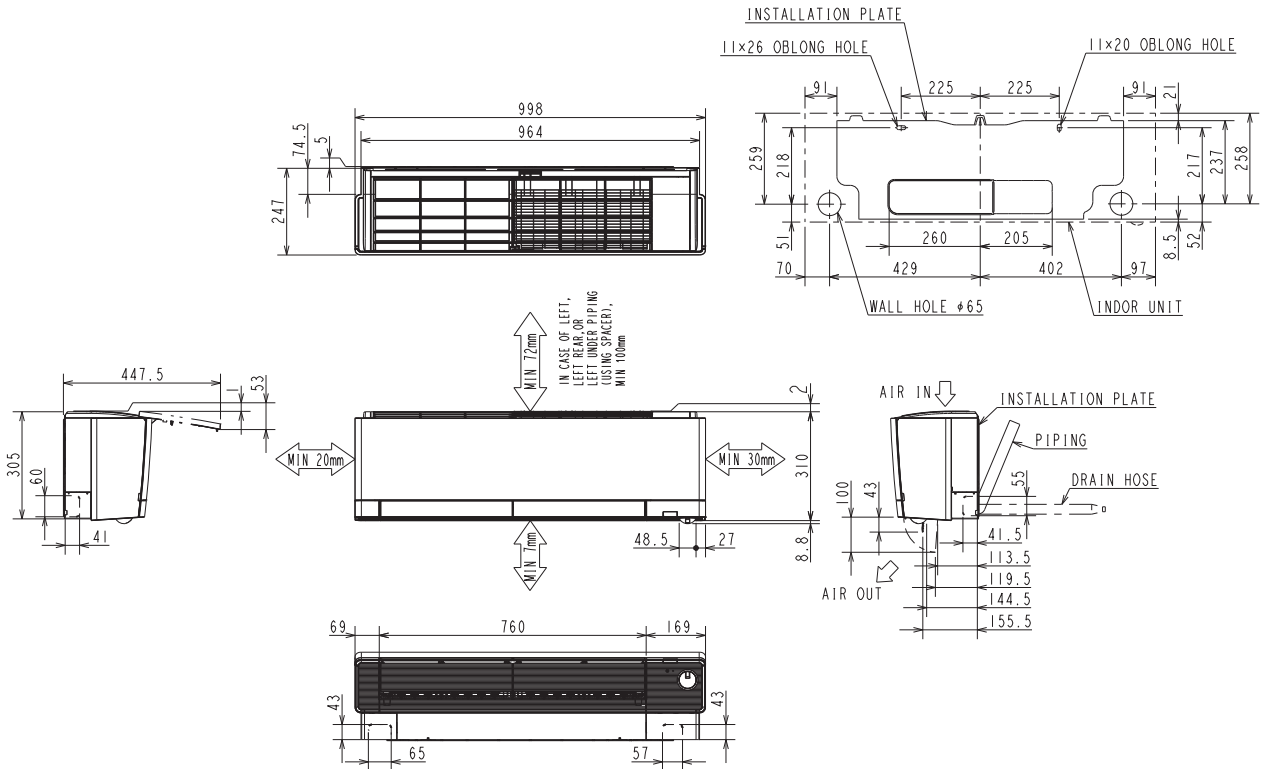

MSZ-RZ25/35VU - [E1]

PIPING	INSULATION	ø40 O.D
	LIQUID LINE	ø6.35 - 0.5 m (FLARED CONNECTION ø6.35)
	GAS LINE	ø9.52 - 0.45 m (FLARED CONNECTION ø9.52)
DRAIN HOSE		INSULATION ø29 CONNECTED PART ø16 O.D

MSZ-RZ25/35VU - [SC1]

PIPING	INSULATION	ø40 O.D
	LIQUID LINE	ø6.35 - 0.64 m (FLARED CONNECTION ø6.35)
	GAS LINE	ø9.52 - 0.59 m (FLARED CONNECTION ø9.52)
DRAIN HOSE		INSULATION ø29 CONNECTED PART ø16 O.D

MSZ-RZ50VU - [E1]

PIPING	INSULATION	ø40 O.D
	LIQUID LINE	ø6.35 - 0.5 m (FLARED CONNECTION ø6.35)
	GAS LINE	ø9.52 - 0.45 m (FLARED CONNECTION ø12.7)
DRAIN HOSE		INSULATION ø29 CONNECTED PART ø16 O.D

MSZ-RZ50VU - [SC1]

PIPING	INSULATION	ø40 O.D
	LIQUID LINE	ø6.35 - 0.64 m (FLARED CONNECTION ø6.35)
	GAS LINE	ø9.52 - 0.59 m (FLARED CONNECTION ø12.7)
DRAIN HOSE		INSULATION ø29 CONNECTED PART ø16 O.D

7

WIRING DIAGRAM

MSZ-RZ25VU MSZ-RZ35VU MSZ-RZ50VU

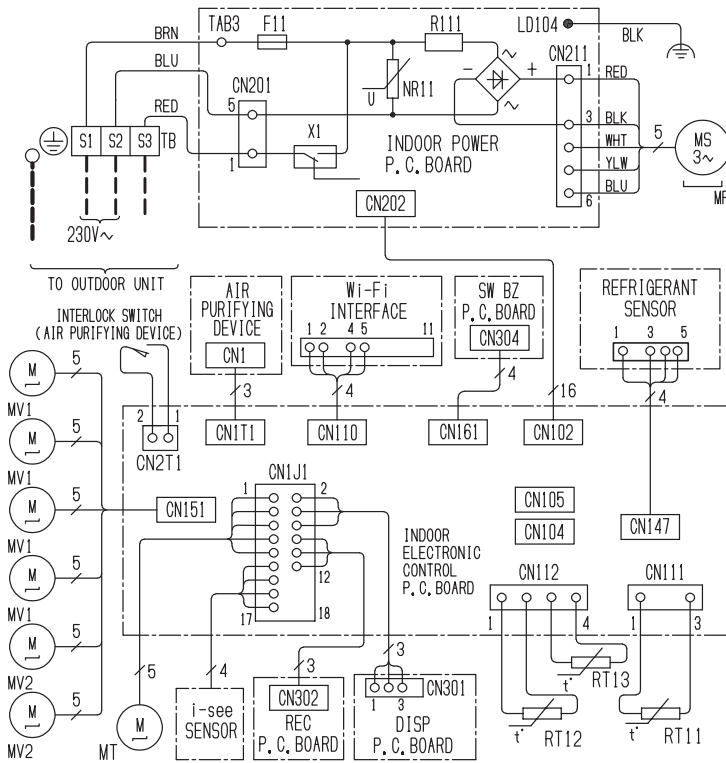

SYMBOL	NAME
F11	FUSE (T3, 15AL250V)
MF	FAN MOTOR
MV1	VANE MOTOR (HORIZONTAL)
MV2	VANE MOTOR (VERTICAL)
MT	i-see SENSOR MOTOR
NR11	VARISTOR
R111	RESISTOR
RT11	ROOM TEMP. THERMISTOR
RT12	COIL TEMP. THERMISTOR (MAIN)
RT13	COIL TEMP. THERMISTOR (SUB)
TB	TERMINAL BLOCK
X1	RELAY

NOTES: 1. About the outdoor side electronic wiring refer to the outdoor unit electronic wiring diagram for servicing.
 2. Use copper supply wires.
 3. Symbols indicate, : Terminal block : Connector

8

REFRIGERANT SYSTEM DIAGRAM

MSZ-RZ25VU

MSZ-RZ35VU

Unit: mm

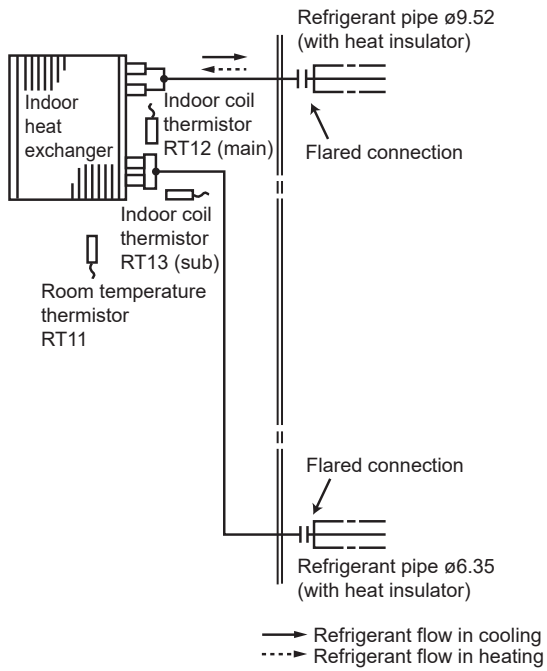

MSZ-RZ50VU

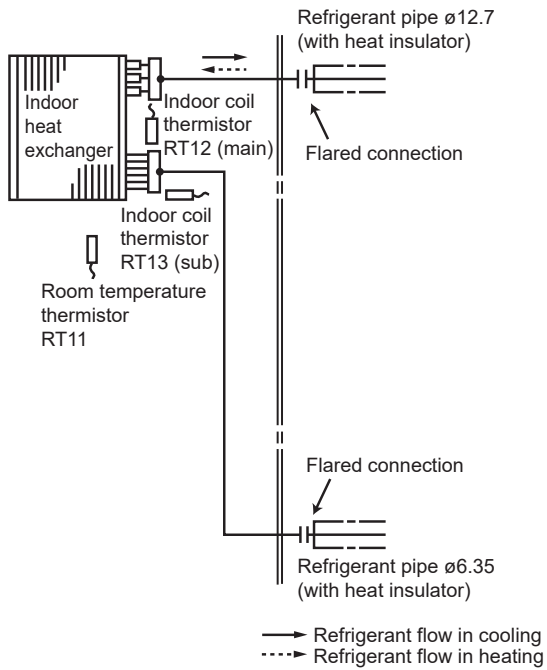

9

SERVICE FUNCTIONS

MSZ-RZ25VU MSZ-RZ35VU MSZ-RZ50VU

9-1. TIMER SHORT MODE

For service, the following set time can be shortened by bridging the timer short mode point on the electronic control P.C. board.

(Refer to 11-7.)

- The set time for the ON/OFF timer can be reduced to 1 second for each minute.
- After the breaker is turned on, the time for starting the compressor, which normally takes 3 minutes, can be reduced to 1 minute. Restarting the compressor, which takes 3 minutes, cannot be reduced.

9-2. HOW TO SET REMOTE CONTROLLER EXCLUSIVELY FOR A PARTICULAR INDOOR UNIT

A maximum of 4 indoor units with wireless remote controllers can be used in a room.

To operate the indoor units individually with each remote controller, assign a number to each remote controller according to the number of the indoor unit.

This setting can be set only when all the following conditions are met:

- The remote controller is powered OFF.
- Weekly timer is not set.
- Weekly timer is not being edited.

(1) Hold down  button on the remote controller for 2 seconds to enter the pairing mode.

(2) Press  button again and assign a number to each remote controller.

Each press of  button advances the number in the following order: 1 → 2 → 3 → 4.

(3) Press  button to complete the pairing setting.

After you turn the breaker ON, the remote controller that first sends a signal to an indoor unit will be regarded as the remote controller for the indoor unit.

Once they are set, the indoor unit will only receive the signal from the assigned remote controller afterwards.

9-3. SETTING THE INSTALLATION POSITION

Be sure to set the remote controller according to the installed position of the indoor unit.

Installation position:

Left: Distance to objects (wall, cabinet, etc.) is less than 50 cm to the left

Center: Distance to objects (wall, cabinet, etc.) is more than 50 cm to the left and right

Right: Distance to objects (wall, cabinet, etc.) is less than 50 cm to the right

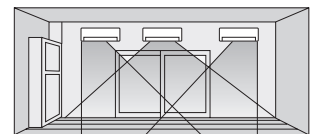

(Left)(Center)(Right)







The installation position can be set only when all the following conditions are met:

- The remote controller is powered OFF.
- Weekly timer is not set.
- Weekly timer is not being edited.

(1) Hold down  button on the remote controller for 2 seconds to enter the position setting mode.

(2) Select the target installation position by pressing  button. (Each press of the  button displays the positions in order: center → right → left.)

(3) Press  button to complete the position setting.

Installation position	Left	Center	Right
Remote controller display			

9-4. AUTO RESTART FUNCTION

When the indoor unit is controlled with the remote controller, the operation mode, the set temperature, and the fan speed are memorized by the indoor electronic control P.C. board. "AUTO RESTART FUNCTION" automatically starts operation in the same mode just before the shutoff of the main power.

Operation

- ① If the main power has been cut, the operation settings remain.
- ② After the power is restored, the unit restarts automatically according to the memory.
(However, it takes at least 3 minutes for the compressor to start running.)

How to disable "AUTO RESTART FUNCTION"

- ① Turn off the main power for the unit.
- ② Cut the jumper wire to JR77 on the indoor electronic control P.C. board. (Refer to 11-7.)

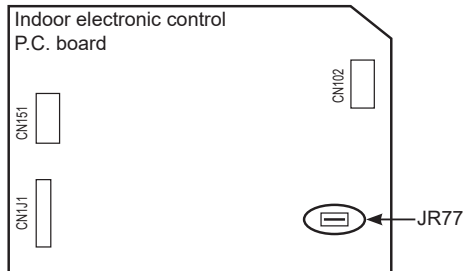

NOTE:

- The operation settings are memorized when 10 seconds have passed after the indoor unit was operated with the remote controller.
- If main power is turned OFF or a power failure occurs while AUTO START/STOP timer is active, the timer setting is cancelled.
- If the unit has been turned OFF with the remote controller before power failure, the auto restart function does not work as the power button of the remote controller is OFF.
- To prevent the breaker from tripping OFF due to the rush of starting current, systematize other home appliance not to turn ON at the same time.
- When some air conditioners are connected to the same supply system, if they are operated before power failure, the starting current of all the compressors may flow simultaneously at restart. Therefore, the special counter-measures are required to prevent the main voltage-drop or the rush of the starting current by adding to the system that allows the units to start one by one.

9-5. Wi-Fi MODULE SETTING UP

This Wi-Fi module communicates the status information and controls the commands from the MELCloud by connecting to an indoor unit.

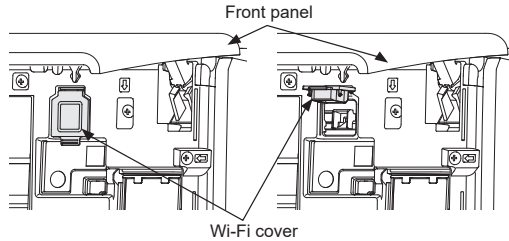

1. Wi-Fi module introduction

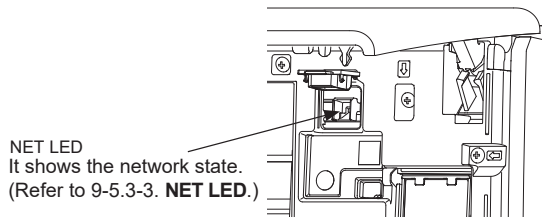

2. Setting up

Set up a connection between the Wi-Fi module and the router.

NOTE:

Setup is possible only after operating the air conditioner using the wireless remote controller.

For MELCloud User Manual, please go to the website below.
<http://www.melcloud.com/Support>

3. Selecting a mode

The Wi-Fi module has to be paired with the router in order for communication between the indoor unit and MELCloud to begin. There are 2 methods of pairing the Wi-Fi module with the router:

- WPS-PUSH mode
- Access Point mode

The mode to be set depends on whether your router has the WPS button.

Use the pairing mode most suitable for your system.

Follow the instructions below to set the pairing mode with remote controller.

Set up the Wi-Fi module and the router again when the router has been replaced.

To reset connection and set up the Wi-Fi module and the router again

- (1) Hold down the Temperature \ominus for 5 seconds.
- (2) Select “_ 2” by pressing Temperature \oplus and \ominus .
- (3) Point the remote controller toward the indoor unit and press the OFF/ON .
- (4) The indoor unit beeps 3 times when resetting is complete.

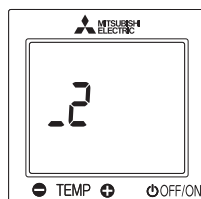

3-1. Setting up in WPS-PUSH mode

To enter the mode

- (1) Hold down the Temperature \oplus for 5 seconds.
- (2) Select “_ 2” by pressing Temperature \oplus and \ominus as shown on the right.
- (3) Point the remote controller toward the indoor unit and press the OFF/ON .

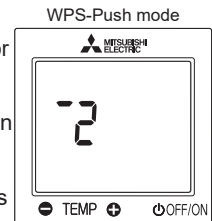

3-1.1. Connect the router to the air conditioner.

Make sure that the LED indication is as shown below.

Push WPS button of the router within 2 minutes after the mode selection has completed.

The WPS-PUSH mode will return to initial state if WPS button is not pressed for 2 minutes.

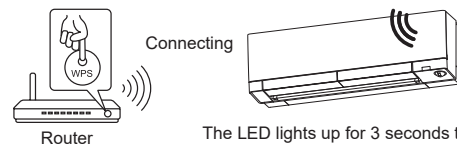

The LED lights up for 3 seconds then blinks twice. A beep sounds as the LED blinks. This series of actions is repeated.

3-1-2. LED will be as shown below when connection between the router and Wi-Fi module is completed and connection to MELCloud starts.

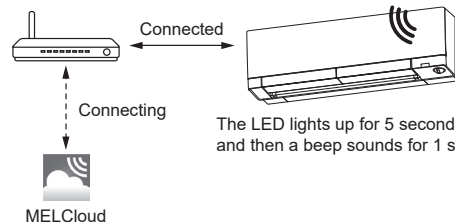

The LED lights up for 5 seconds and then a beep sounds for 1 second.

NOTE:

If the indication LED does not change or blinks 5 times, connection fails. Please reset connection and setup the Wi-Fi module and the router again.

Main causes that WPS failed are as follows.

Communication distance (from the Wi-Fi module to router), router settings (encryption, authentication, limit of connections, etc.)

3-2. Setting up in Access Point mode

Complete the setting up in the Access Point mode within 10 minutes.

To enter the mode

- (1) Hold down the Temperature \oplus for 5 seconds.
- (2) Select “1” by pressing Temperature \oplus and \ominus as shown on the right.
- (3) Point the remote controller toward the indoor unit and press the OFF/ON \odot .

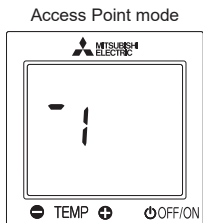

3-2.1. Connect your smartphone to the air conditioner.

Make sure that the LED indication is as shown below. On the Wi-Fi Setting Screen on your smartphone, select SSID and enter KEY, which are printed on the information label.

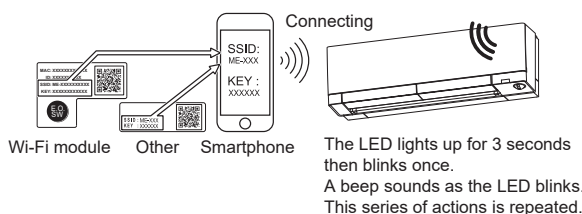

NOTE:

- Check Wi-Fi setting of your smartphone if SSID does not appear on it.
- Enter KEY again if SSID appears on your smartphone, but it cannot connect to the Wi-Fi module.
- The LED (Air purifying lamp of the indoor unit) indication does not change or blinks 5 times if connection fails. In that case, reset connection and set up the Wi-Fi module and the router again.

3-2.2. Access URL (<http://192.168.11.1/network>) by any of the following methods to display the setting screen.

- (1) Scan the matrix barcode on the information label.
- (2) Type the URL (<http://192.168.11.1/network>) in the web browser.

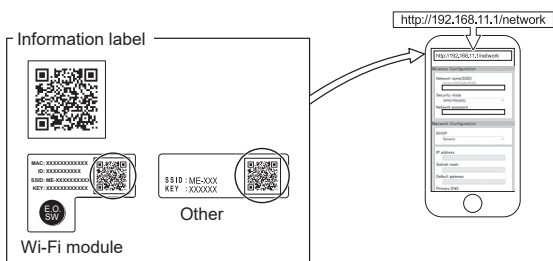

3-2.3. Register the information of the router on the air conditioner.

In the displayed window, select Dynamic in DHCP (*1) and enter the information of router, then tap the Submit button.

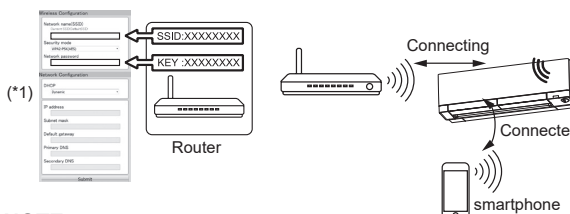

NOTE:

- If you want to use Static, select Static in DHCP (*1) and enter the information of router and network, then tap the Submit button.
- LED indication will return to initial state, if the connection fails.
- LED blinking and beep sounds will stop when the connection is completed.

3-2.4. LED indication will be as shown below when connection between the router and Wi-Fi module is completed and connection to MELCloud starts.

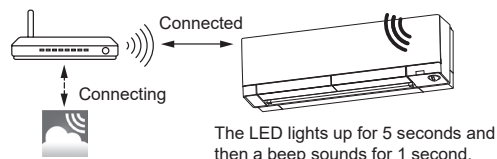

NOTE:

- It may take several minutes to show the indication above. The LED indication does not change or blinks 5 times if connection fails.
- In that case, reset connection and set up the Wi-Fi module and the router again.

3-3. NET LED





NET LED blinking indicates that the Wi-Fi module is communicating with the router.

3-4. When it doesn't connect well

Check the following, and pair the Wi-Fi module and the router according to Selecting a mode.

- Make sure that the communication distance is not too far between the Wi-Fi module and the router.
- Make sure that the router uses WPA2-AES encryption.
- Make sure that the number of connected devices to the router does not exceed the limit.
- Make sure that DHCP is enabled, or check IP address setting of the Wi-Fi module.
- Check DNS settings of the router, or check DNS address of the Wi-Fi module.
- Check if the router is connected to Internet.
- Set up the Wi-Fi module after operating the air conditioner using the wirelessremote controller at least once.

If the connection fails even after checking the above, set up the Wi-Fi module and the router again by the following method.

- Hold down the Temperature  for 5 seconds.
- Select “_ 2” by pressing Temperature  and .
- Point the remote controller toward the indoor unit and press the  .
- The indoor unit beeps 3 times when resetting is complete.

[About trademarks]

- WPS is the connection via Wi-Fi Protected Setup.
- “Wi-Fi®”, “Wi-Fi Protected Setup™”, “WPA2™” are trademarks or registered trademarks of the Wi-Fi Alliance.

For Declaration of Conformity and MELCloud User Manual, please go to the website below.
<http://www.melcloud.com/Support>

The Wi-Fi module uses Open Source Software. To view the Open Source software licence(s), please go to the following website whilst connected to the Wi-Fi module during the Access Point mode.
<http://192.168.11.1/license>

NOTE:

- Ensure that the router supports the WPA2-AES encryption setting before starting the Wi-Fi module setup.
- The End user should read and accept the terms and conditions of the Wi-Fi service before using this Wi-Fi module.
- To complete connection of this Wi-Fi module to the Wi-Fi service, the router may be required.
- This Wi-Fi module will not commence transmission of any operational data from the system until the End user registers and accepts the terms and conditions of the Wi-Fi service.
- This Wi-Fi module should not be installed and connected to any Mitsubishi Electric system which is to provide application critical cooling or heating.
- At the time of relocation or disposal, reset the Wi-Fi module to the factory default.

Mitsubishi Electric's Wi-Fi module is designed for communication to Mitsubishi Electric's MELCloud Wi-Fi service. Mitsubishi Electric is not responsible for any (i) underperformance of a system or any product; (ii) system or product fault; or (iii) loss or damage to any system or product; which is caused by or arises from connection to and/or use of any third party Wi-Fi module or any third party Wi-Fi service with Mitsubishi Electric equipment.

For the latest information regarding MELCloud from Mitsubishi Electric Corporation, please visit www.melcloud.com.

9-6. CHANGING THE CORRECTION VALUE OF THE ROOM TEMPERATURE (THE INLET TEMPERATURE)

The correction value of the room temperature can be adjusted in the range of 2 to 5 °C with the remote controller.

Normally, the temperature at the room temperature sensor might become higher than that around floor because warm air tends to accumulate around an indoor unit during heating operation.

Thus, if you correct the room temperature to the temperature about 2 °C lower than that detected by the room temperature sensor, the air conditioner capacity during heating operation increases, which suppresses a decrease in the temperature around floor.

The optimal correction values of the room temperature, however, might differ depending on the installation environments such as installation height of the indoor unit or the ceiling height, so adjust the correction value of the room temperature in the range of 2 to 5 °C with the remote controller.

NOTE 1: The room will be warmer if you set the correction value of the room temperature to 5°C.

1. How to change the correction value of the room temperature

(1) Press [① OFF/ON] button on the remote controller to turn the indoor unit off. (Figure 1)

(2) Point the remote controller at the indoor unit.

While you hold down [② MODE] and [③ TEMP \ominus] at the same time, press [④ RESET], and keep holding [② MODE] and [③ TEMP \ominus] to indicate the correction value of the room temperature that was set the last time with the remote controller (Figure 2 shows 2°C at factory setting).

NOTE 2: Point the remote controller at the indoor unit while working in the procedure (3) and (4) like the procedure (2).

(3) Press [③ TEMP \ominus] or [⑤ TEMP \oplus] to change the correction value of the room temperature.

(4) Set the correction value of the room temperature to the desired value, and then press [① OFF/ON] button on the remote controller to turn the indoor unit off. (Figure 1)

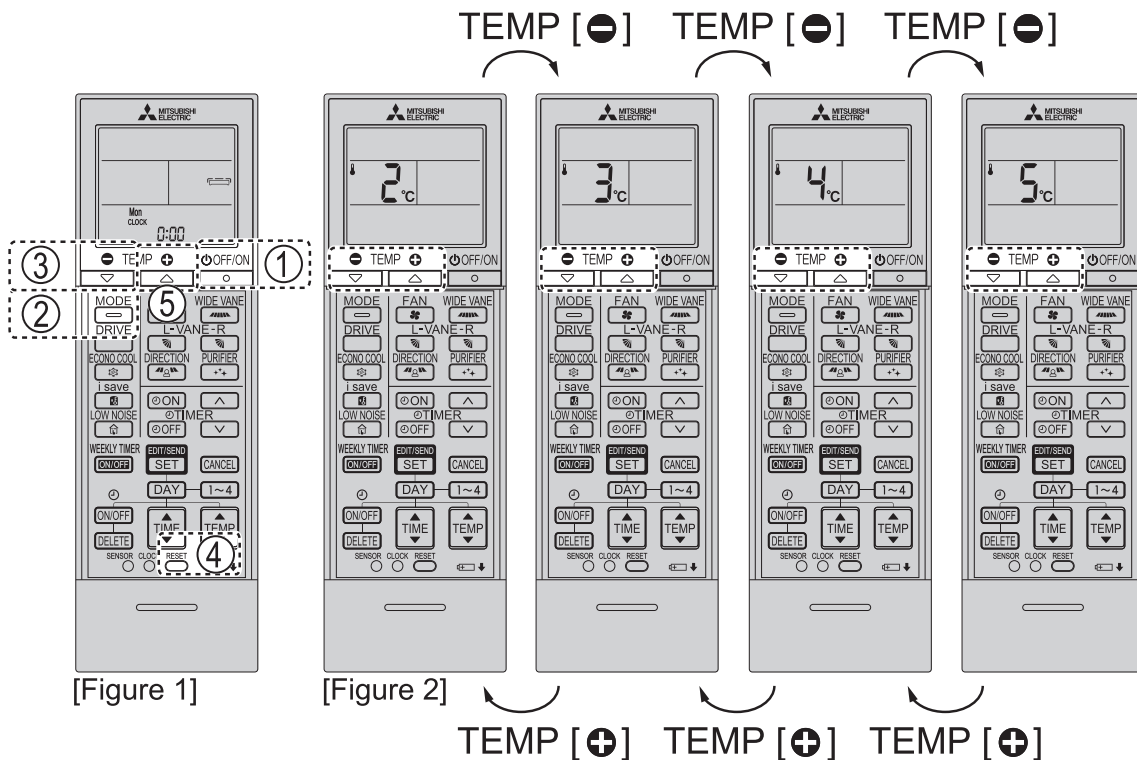

2. Writing the correction value of the room temperature on the wiring diagram

After setting the correction value of the room temperature (the inlet air temperature), follow 12. DISASSEMBLY INSTRUCTIONS to disassemble the indoor unit, and then circle the correction value (any of 3, 4, or 5) on the wiring diagram (e.g. The correction value is circled within the area.) (Figure 3)

If the indoor electronic control P.C. board is replaced in servicing, the correction value is reset. The numerical value (any of 3, 4, or 5) described on the wiring diagram will be needed when a service person sets the correction value again after replacing the P.C. board.

NOTE 3: The instruction for setting the correction value again is attached to the indoor electronic control P.C. board of the service part as well.

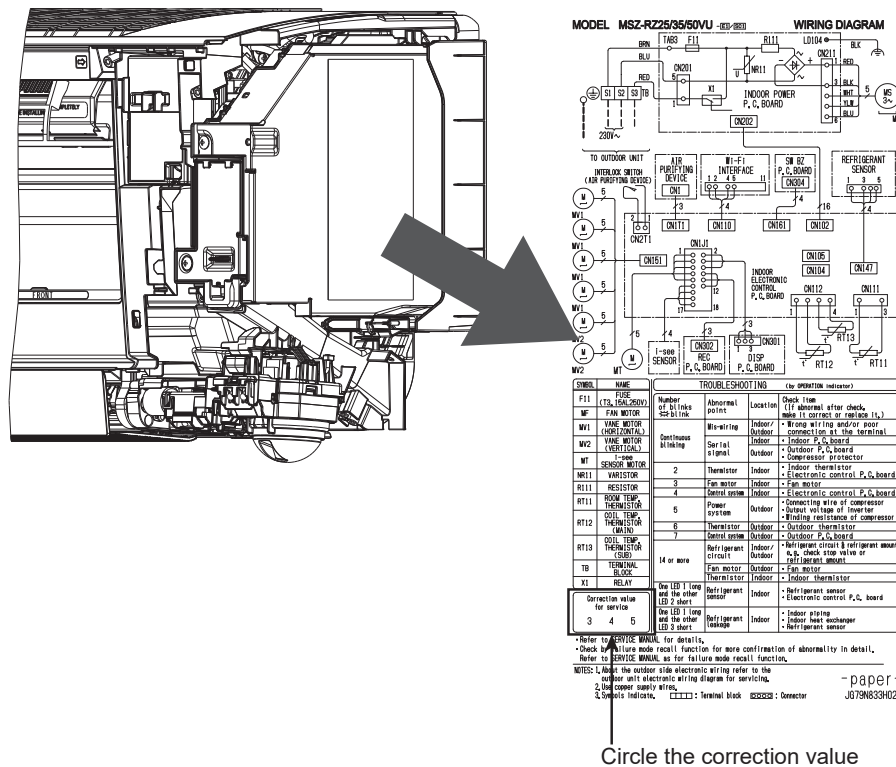

[Figure 3]

If you cut the jumper wire JR24 (Refer to 11-7.), a correction value of the room temperature during heating operation turns to 0°C regardless of the correction commands from the remote controller. (Figure 4)

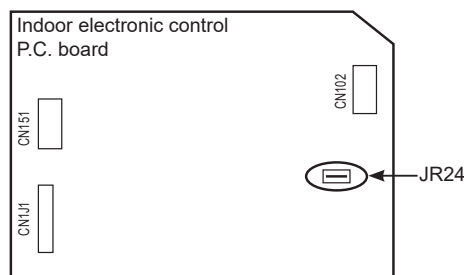

[Figure 4]

9-7. ADJUSTING POSITION GAPS BETWEEN THE LEFT AND RIGHT HORIZONTAL VANES AT UPPER AND LOWER SIDE

When there are position gaps between the left and right horizontal vanes at upper and lower side, follow the procedure below for the service.

1. Prior check

Checks before repairing: check following items (a) to (e) if there are factors causing torsion on the body of the indoor unit installed. Correct the factor if there is a problem.

- (a) Bumps on the installation surface due to a lumber or others.
- (b) Contact of the indoor unit or an installation board with a pillar.
- (c) The wall sleeve, pipes, or drain hose cause the lower part of the indoor unit to be lifted toward you.
- (d) Deformation of a nozzle due to tension of the drain hose or pipes.
- (e) An installation board not installed as described in the installation manual
(Refer to the installation manual.)

NOTE 1: If there is no problem in (a) to (e) items, follow the procedure 9-7.2. "How to adjust position gaps of the vanes" below for the service.

2. How to adjust position gaps of the vanes

Prepare the remote controller attached with the product (hereinafter, remote controller). Follow the procedure below to fine-adjust the position gaps (angle) between the left and right vanes at upper and lower side.

NOTE 2: You cannot return the vanes to initial state (angle) by resetting their adjustments amount once adjusting the left and right vanes at upper and lower side.

- (1) Supply the power with the air conditioner.
- (2) Press [① OFF/ON] button on the remote controller to turn the air conditioner and the remote controller off.
- (3) While holding down [② VANE-L] and [③ VANE-R] on remote controller, press [④ RESET], and keep holding [② VANE-L] and [③ VANE-R] until the display changes as shown in Figure 2.
The settings of "cooling" and "horizontal vane angle 1 (horizontal position)" are sent to the indoor unit, and the unit starts the vane adjusting mode.

NOTE 3: Return to (1) if the air conditioner does not operate.

- (4) When the upper and lower vanes are set to the "horizontal vane angle 1 (horizontal position)", press [⑤ [△][▽]] buttons or [⑥ [^][v]] buttons on the remote controller to move the positions (angle) of the left vanes need for adjustment.
Pressing [⑤ [△][▽]] buttons moves the upper left vane and pressing [⑥ [^][v]] buttons moves the lower left vane. Align the positions of the left vanes with those of the right vanes respectively.
- (5) After the adjustment work is complete, pressing [① OFF/ON] button on the remote controller once allows the remote controller to be turned off as shown in Figure 1; however, the air conditioner does not turn off.
Press [① OFF/ON] button twice more continuously to turn the air conditioner and the remote controller off.
- (6) Adjustment work is complete. Start cooling operation normally to confirm the operation.

NOTE 4 :

- The gap amounts between the left and right vanes at upper and lower side at each vane position (setting position) might differ depending on the installation conditions. (Please adjust the vanes visually with the indoor unit installed if using the remote controller to correct the position gaps between vanes).
- This method with the remote controller does not support for correcting the position gaps between the vanes with them fully closed and the gaps between the vanes and the body of the indoor unit installed.
Check 9-7.1. Prior check whether torsion on the body of the indoor unit installed leads to the position gaps between the vanes with them fully closed or not.
- The adjustments amount using the remote controller neither can be reset nor checked.
- To return the vanes to the initial state, replace the indoor electric control P.C board.
- When the P.C board is replaced after the position gaps have been corrected, readjust the gaps between the left and right vanes at upper and lower side.

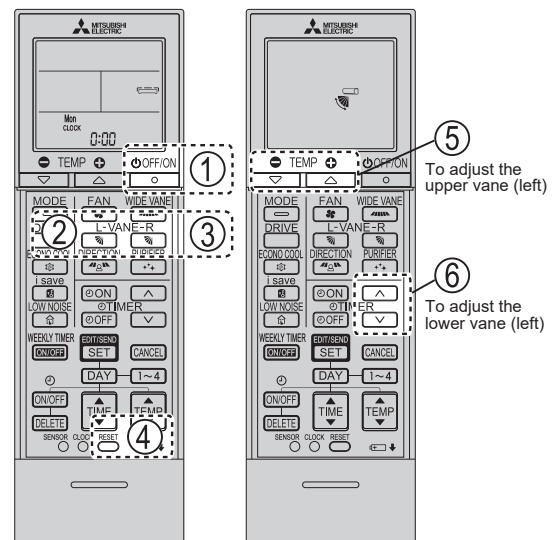

[Figure 1]

Remote controller state:
OFF

[Figure 2]

Remote controller state:
Vane adjusting mode.
(The vane adjusting mode is not canceled even if a certain period has elapsed.)

MSZ-RZ25VU - [E1] MSZ-RZ35VU - [E1] MSZ-RZ50VU - [E1]

WIRELESS REMOTE CONTROLLER

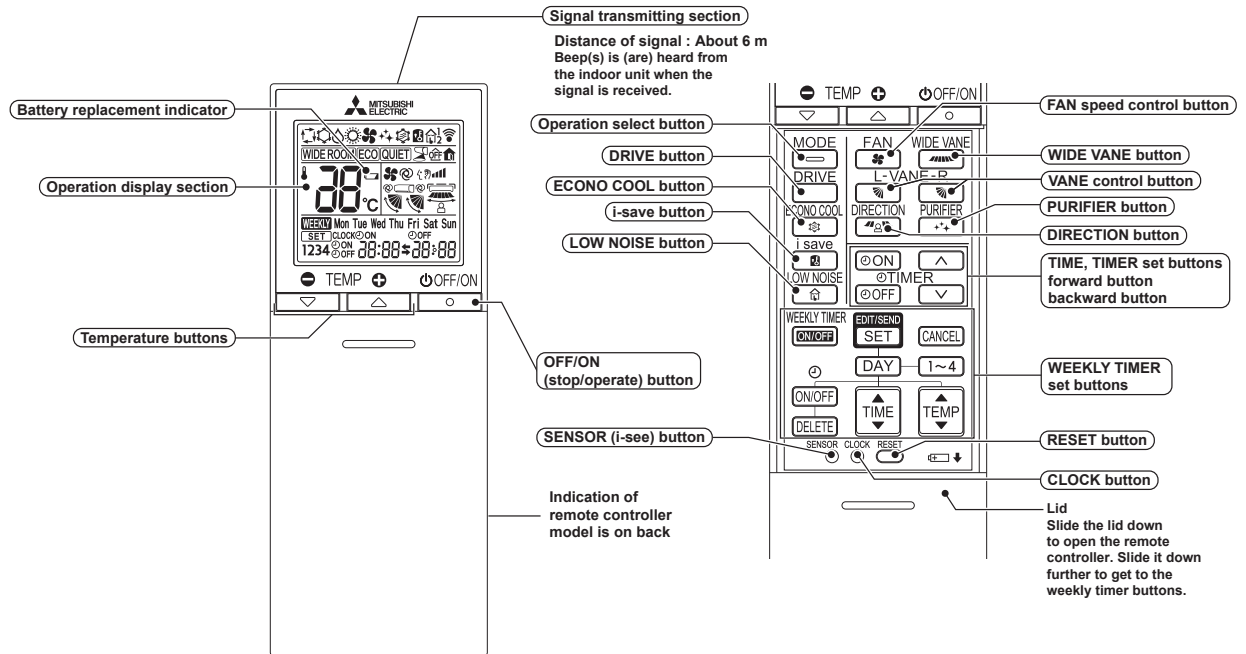

NOTE: Last setting will be stored after the unit is turned OFF with the remote controller. Indoor unit receives the signal of the remote controller with beeps.

MSZ-RZ25VU - [SC1] MSZ-RZ35VU - [SC1] MSZ-RZ50VU - [SC1]

WIRELESS REMOTE CONTROLLER

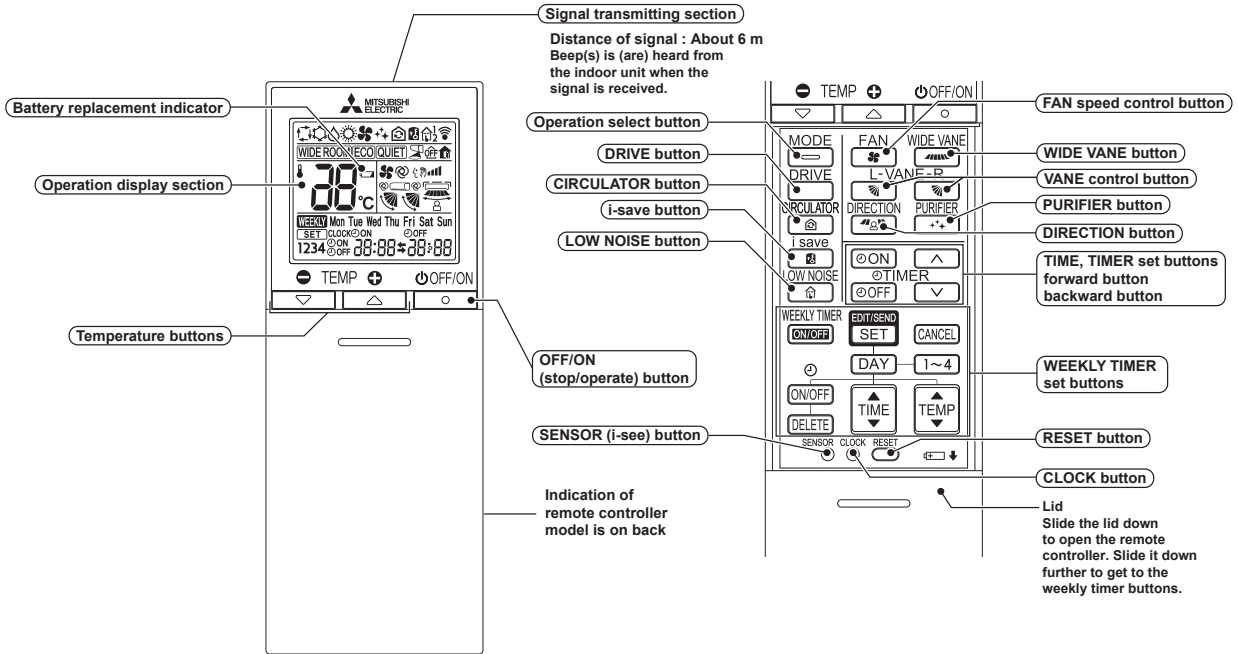

NOTE: Last setting will be stored after the unit is turned OFF with the remote controller. Indoor unit receives the signal of the remote controller with beeps.

10-1. COOL (❄️) OPERATION

- (1) Press OFF/ON (stop/operate) button.
OPERATION INDICATOR lamp of the indoor unit turns on with a beep tone.
- (2) Select COOL mode with Operation select button.
- (3) Press Temperature buttons TEMP \ominus or \oplus button to select the desired temperature. The setting range is 16 - 31°C.

1. Coil frost prevention

The compressor operational frequency is controlled by the temperature of the indoor heat exchanger to prevent the coil from frosting.

When the temperature of indoor heat exchanger becomes too low, the coil frost prevention mode works.

The indoor fan operates at the set speed and the compressor stops. This mode continues until the temperature of indoor heat exchanger rises.

2. Low outside temperature operation

When the outside temperature is lower, low outside temperature operation starts, and the outdoor fan slows or stops.

3. Indoor fan speed control

When the thermostat turns OFF, the indoor fan operates very Low to reduce power consumption.

When the room temperature rises and the thermostat is ON, the indoor fan operates according to the settings on the remote controller.

10-2. DRY (☀️) OPERATION

- (1) Press OFF/ON (stop/operate) button.
OPERATION INDICATOR lamp of the indoor unit turns on with a beep tone.
- (2) Select DRY mode with Operation select button.
- (3) The set temperature is determined from the initial room temperature.

1. Coil frost prevention

Coil frost prevention works the same way as that in COOL mode. (10-1.1.)

2. Low outside temperature operation

Low outside temperature operation works the same way as that in COOL mode. (10-1.2.)

3. Indoor fan speed control

Indoor fan speed control works the same way as that in COOL mode. (10-1.3.)

10-3. FAN (🌀) OPERATION

- (1) OPERATION INDICATOR lamp of the indoor unit turns on with a beep tone.
- (2) Select FAN mode with Operation select button.
- (3) Select the desired fan speed. When AUTO, it becomes Low.
Only indoor fan operates.
Outdoor unit does not operate.

10-4. HEAT (🔥) OPERATION

- (1) Press OFF/ON (stop/operate) button.
OPERATION INDICATOR lamp of the indoor unit turns on with a beep tone.
- (2) Select HEAT mode with Operation select button.
- (3) Press Temperature buttons TEMP \ominus or \oplus button to select the desired temperature. The setting range is 10 - 31°C.

1. Cold air prevention control

When the compressor is not operating or is starting, and the temperature of indoor heat exchanger and/or the room temperature is low or when defrosting is being done, the indoor fan will stop or rotate in Very Low speed.

2. High pressure protection

The compressor operational frequency is controlled by the temperature of the indoor heat exchanger to prevent the condensing pressure from increasing excessively.

When the temperature of indoor heat exchanger becomes too high, the high pressure protection works.

The indoor fan operates following the cold air prevention control. This mode continues until the temperature of indoor heat exchanger falls.

3. Defrosting

Defrosting starts when the temperature of outdoor heat exchanger becomes too low.

The compressor stops once, the indoor/outdoor fans stop, the 4-way valve reverses, and the compressor re-starts.

This mode continues until the temperature of outdoor heat exchanger rises or the fixed time passes.

10-5. AUTO CHANGE OVER ... AUTO MODE OPERATION

Once desired temperature is set, unit operation is switched automatically between COOL and HEAT operation.

Mode selection

(1) Initial mode

When unit starts the operation with AUTO operation from OFF:

- If the room temperature is higher than the set temperature, operation starts in COOL mode.
- If the room temperature is equal to or lower than the set temperature, operation starts in HEAT mode.

(2) Mode change

COOL mode changes to HEAT mode when about 15 minutes have passed with the room temperature 1°C below the set temperature.

HEAT mode changes to COOL mode when about 15 minutes have passed with the room temperature 1°C above the set temperature.

10-6. AUTO VANE OPERATION

1. Horizontal vane

(1) Vane motor drive

These models are equipped with stepping motors for the horizontal vanes. The rotating direction, speed, and angle of the motor are controlled by pulse signals (approximately 12 V) transmitted from indoor microprocessor.

(2) The horizontal vane angle and mode change as follows by pressing VANE CONTROL () button.

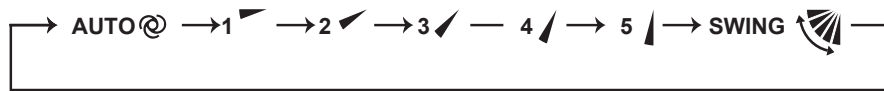

NOTE: The right and left horizontal vanes set to the same level may not align perfectly.

(3) Positioning

To confirm the standard position, the vane moves until it touches the vane stopper. Then the vane is set to the selected angle.

Confirmation of standard position is performed in the following cases:

- When the operation starts or finishes (including timer operation).
- When the test run starts.
- When standby mode (only during multi system operation) starts or finishes.

(4) VANE AUTO (Ⓐ) mode

In VANE AUTO mode, the microprocessor automatically determines the vane angle to make the optimum room temperature distribution.

In COOL and DRY operation

Vane angle is fixed to Horizontal position.

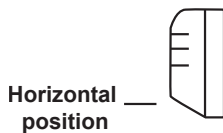

In HEAT operation

Vane angle is fixed to Angle 4.



(5) STOP (operation OFF) and ON TIMER standby

In the following cases, the horizontal vane returns to the closed position.

- When OFF/ON (stop/operate) button is pressed (POWER OFF).
- When the operation is stopped by the emergency operation.
- When ON TIMER is ON standby.

(6) Dew prevention

During COOL or DRY operation with the lower position when the compressor cumulative operation time exceeds 1 hour, the vane angle automatically changes to Angle 1 for dew prevention.

(7) SWING (🌀) mode

By selecting SWING mode with VANE control button, the horizontal vanes swing vertically.

When COOL, DRY or FAN mode is selected, only the upper vane swings.

(8) Cold air prevention in HEAT operation

The horizontal vane position is set to Upward.

NOTE: When 2 or more indoor units are operated with multi outdoor unit, even if any indoor unit turns thermostat off, this control does not work in the indoor unit.

(9) ECONO COOL (🌡️) operation (ECONOMical operation) (MSZ-RZ25/35/50VU-ET only)

When ECONO COOL button is pressed in COOL mode, set temperature is automatically set 2°C higher by the microprocessor. However, the temperature on the LCD screen on the remote controller is not changed. Also the horizontal vane swings in various cycle.

SWING operation makes you feel cooler than set temperature. So, even though the set temperature is higher, the air conditioner can keep comfort. As a result, energy can be saved.

To cancel this operation, select a different mode or press one of the following buttons in ECONO COOL operation: ECONO COOL or VANE control button.

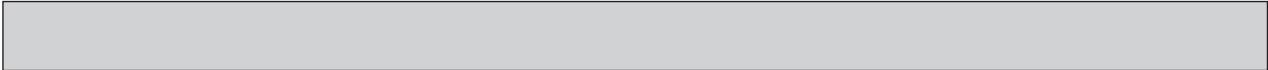

2. Vertical vane

(1) Vane motor drive

These models are equipped with a stepping motor for the vertical vane. The rotating direction, speed, and angle of the motor are controlled by pulse signals (approximately 12 V) transmitted from microprocessor.

(2) The vertical vane angle and mode change as follows by pressing WIDE VANE button.

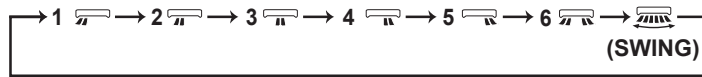

(3) Positioning

To confirm the standard position, the vane moves until it touches the vane stopper. Then the vane is set to the selected angle.

Confirmation of standard position is performed in the following cases:

(a) OFF/ON (stop/operate) button is pressed (POWER ON).

(4) SWING (SWING) MODE

By selecting SWING mode with WIDE VANE button, the vertical vane swings horizontally. The remote controller displays "SWING". Swing mode is cancelled when WIDE VANE button is pressed once again.

10-7. TIMER OPERATION

1. How to set the time

(1) Check that the current time is set correctly.

NOTE: Timer operation will not work without setting the current time. Initially "0:00" blinks at the current time display of TIME MONITOR, so set the current time correctly with CLOCK button.

How to set the current time

(a) Press the CLOCK button.

(b) Press the TIME set buttons (\uparrow) and (\downarrow) to set the current time.

- Each time forward button (\uparrow) is pressed, the set time increases by 1 minute, and each time backward button (\downarrow) is pressed, the set time decreases by 1 minute.

- Pressing those buttons longer, the set time increases/decreases by 10 minutes.

(c) Press the CLOCK set button.

(2) Press OFF/ON (stop/operate) button to start the air conditioner.

(3) Set the time of timer.

ON timer setting

(a) Press ON TIMER button (\odot ON) during operation.

(b) Set the time of the timer using TIME set buttons (\uparrow) and (\downarrow).*

OFF timer setting

(a) Press OFF TIMER button (\odot OFF) during operation.

(b) Set the time of the timer using TIME set buttons (\uparrow) and (\downarrow).*

* Each time forward button (\uparrow) is pressed, the set time increases by 10 minutes: each time backward button (\downarrow) is pressed, the set time decreases by 10 minutes.

2. To release the timer

To release ON timer, press ON TIMER button (\odot ON).

To release OFF timer, press OFF TIMER button (\odot OFF).

TIMER is cancelled and the display of set time disappears.

PROGRAM TIMER

• OFF timer and ON timer can be used in combination. The set time that is reached first will operate first.

• "➡" and "⬅" display shows the order of OFF timer and ON timer operation.

(Example 1) The current time is 8:00 PM.

The unit turns off at 11:00 PM, and on at 6:00 AM.

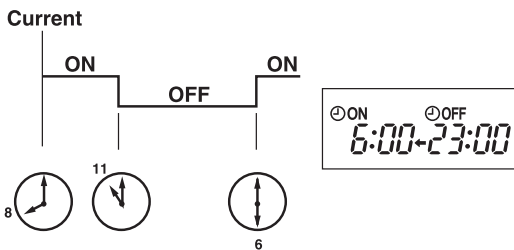

(Example 2) The current time is 11:00 AM.

The unit turns on at 5:00 PM, and off at 9:00 PM.

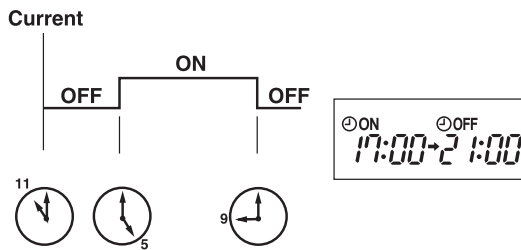

NOTE: If the main power is turned OFF or a power failure occurs while ON/OFF timer is active, the timer setting is cancelled. As these models are equipped with an auto restart function, the air conditioner starts operating with timer cancelled when power is restored.

10-8. WEEKLY TIMER OPERATION

- A maximum of 4 ON or OFF timers can be set for individual days of the week.
- A maximum of 28 ON or OFF timers can be set for a week.

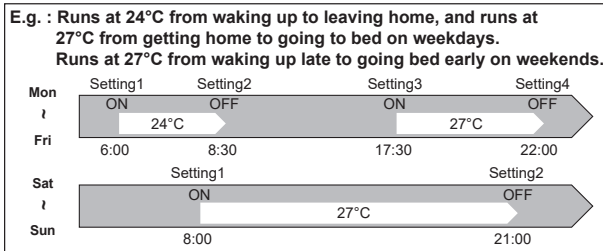

NOTE:

- The simple ON/OFF timer setting is available while the weekly timer is on. In this case, the ON/OFF timer has priority over the weekly timer; the weekly timer operation will start again after the simple ON/OFF timer is complete.

1. How to set the weekly timer

* Make sure that the current time and day are set correctly.

- (1) Press **EDIT/SEND** **SET** button to enter the weekly timer setting mode.

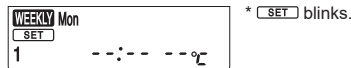

- (2) Press **DAY** and **1~4** buttons to select setting day and number.

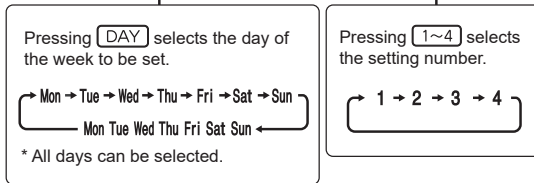
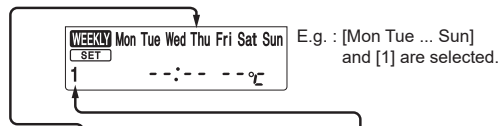

- (3) Press **ON/OFF**, **TIME**, and **TEMP** buttons to set ON/OFF, time, and temperature.

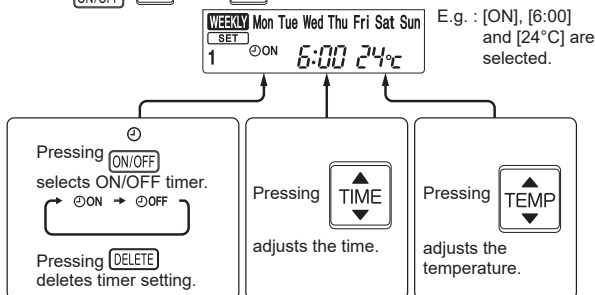

* Hold down the button to change the time quickly.

* The temperature can be set between 16°C and 31°C at COOL operation.

* The temperature can be set between 10°C and 31°C at HEAT operation.





Press **DAY** and **1~4** buttons to continue setting the timer for other days and/or numbers.



- (4) Press  button to complete and transmit the weekly timer setting.





*  which was blinking goes out, and the current time will be displayed.

NOTE:

- Press  button to transmit the setting information of weekly timer to the indoor unit. Point the remote controller toward the indoor unit for 3 seconds.
- When setting the timer for more than one day of the week or one number,  button does not have to be pressed per each setting. Press  button once after all the settings are completed. All the weekly timer settings will be saved.
- Press  button to enter the weekly timer setting mode, and press and hold  button for 5 seconds to erase all weekly timer settings. Point the remote controller toward the indoor unit.

- (5) Press  button to turn the weekly timer ON. ( lights.)

- When the weekly timer is ON, the day of the week whose timer setting is completed, will light.

Press  button again to turn the weekly timer OFF. ( goes out.)



NOTE:

The saved settings will not be cleared when the weekly timer is turned OFF.

2. Checking weekly timer setting

- (1) Press  button to enter the weekly timer setting mode.

*  blinks.



- (2) Press  or  buttons to view the setting of the particular day or number.
 (3) Press  button to exit the weekly timer setting.

NOTE:

When all days of the week are selected to view the settings and a different setting is included among them, --:-- °C will be displayed.

10-9. i-see CONTROL () MODE AND ABSENCE DETECTION

In the i-see control mode, the room temperature is controlled based on the sensible temperature.

- (1) Press  button with a thin instrument during COOL, DRY, HEAT and AUTO mode to activate i-see control mode ().
 The default setting is “active”.
- (2) Press  button several times to cancel i-see control mode.

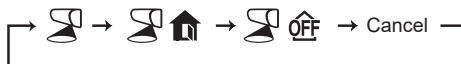

NOTE:

How to detect human presence

- When the air conditioner starts to operate, the i-see Sensor analyzes the temperature of a room by rotating clockwise and counterclockwise.
- Then, it detects human presence by their motion based on their heat signatures.



Detection range

The i-see Sensor does not analyze the temperature in the following range.

- The wall surface on which the air conditioner is installed
- The spot beneath the air conditioner
- Where there is an object (such as furniture) between the place and the air conditioner

It might not detect human and objects properly on the following conditions

- When the temperature of the floor and the wall is high (such as when the air conditioner starts to operate in summer)
- When occupants are in blanket or wear heavily
- When there is an object whose temperature changes rapidly in a short time
- When windows and doors are small or they are far from the air conditioner
- When the sensor cannot detect the heat source such as of small kids or pets
- When using a floor heating or an electric carpet
- When occupants do not move after the air conditioner starts to operate

Refer to the following “Absence Detection” for  and .

ABSENCE DETECTION (🏠)

This function automatically changes the operation to No occupancy energy-saving mode or No occupancy Auto-OFF mode when nobody is in the room.

- (1) To activate this No occupancy energy-saving mode, press SENSOR button until 🏠 appears on the operation display of the remote controller.
- (2) To activate this No occupancy Auto-OFF mode, press SENSOR button until OFF appears on the operation display of the remote controller.
- (3) Press SENSOR button again to cancel the ABSENCE DETECTION.

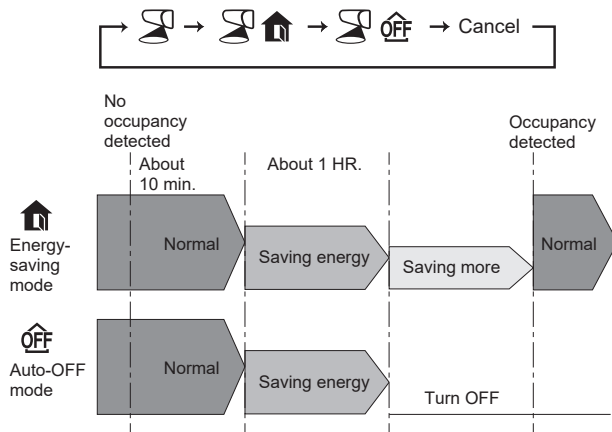

- Even if the unit is turned OFF due to No occupancy Auto-OFF mode, the display of the remote controller remains to indicate the unit is in operation. Press STOP/OPERATE(OFF/ON) button then press STOP/OPERATE(OFF/ON) button again to restart operation.
- When OFF timer is set, a priority is given to OFF timer.
- The unit will not be turned off if no one is detected during normal operation mode, even though No occupancy Auto-OFF mode is activated.

10-10. AIRFLOW CONTROL MODE

AIRFLOW CONTROL mode offers air conditioning according to a location of an occupant in a room detected by i-see SENSOR.

- (1) Press DIRECTION button during COOL, DRY, HEAT or AUTO mode to activate the AIRFLOW CONTROL mode. This mode is only available when the i-see control mode is effective.
- (2) Each press of DIRECTION button changes AIRFLOW CONTROL in the following order:

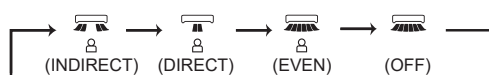

(INDIRECT) : An occupant will be less exposed to direct airflow.

(DIRECT) : Mainly the vicinity of an occupant will be air-conditioned.

(EVEN) : The unit learns the area where an occupant spend most of the time, and evens out the temperature of that area.

NOTE:

- Horizontal and vertical airflow directions will be automatically selected.
 - When more than a couple of people are in a room, the AIRFLOW CONTROL mode may work less effectively.
 - If you still feel uncomfortable with the air direction determined by the INDIRECT mode, adjust the air direction manually.
- (3) Cancelling the i-see control mode automatically cancels the AIRFLOW CONTROL mode.
 - The AIRFLOW CONTROL mode is also cancelled when the VANE control or WIDE VANE buttons is pressed.

10-11. AIR PURIFYING (+) OPERATION

In the AIR PURIFYING operation, the indoor unit built-in device reduces airborne fungi, viruses, mold, and allergens.

- (1) Press PURIFIER button to start AIR PURIFYING operation.
 - Air purifying lamp turns on. (Display section)
- (2) Press PURIFIER button again to cancel AIR PURIFYING operation.
 - Air purifying lamp turns off. (Display section)

NOTE:

- Never touch the air purifying device during operation. Although the air purifying device is safety-conscious design, touching this device could be the cause of trouble as this device discharges high voltage electricity.
- A "hissing" sound may be heard during the air purifying operation. This sound is produced when plasma is being discharged. This is not a malfunction.
- Air purifying lamp does not turn on if the front panel is not closed completely.

10-12. i-save (i) OPERATION

1. How to set i-save operation

- (1) Press OFF/ON (stop/operate) button.
- (2) Select COOL, CIRCULATOR, HEAT, ECONO COOL mode, or LOW NOISE MODE operation.
- (3) Press i-save button.
- (4) Set the temperature, fan speed, and airflow direction for i-save operation.

NOTE:



- i-save operation cannot be selected during DRY, FAN or AUTO mode operation.
- The setting range of HEAT mode i-save operation is 10 - 31°C.
- 2 groups of setting can be saved. (One for COOL/ECONO COOL/CIRCULATOR, one for HEAT)

2. How to cancel operation



- Press i-save button again.
- i-save operation can also be cancelled by pressing Operation select button to change the operation mode.
The preferred setting can be saved for the next time with a single press of i-save button.

10-13. OPERATION LOCK

This function locks operation mode only. Other functions, such as OFF/ON, temperature setting, or airflow direction adjustment, are available.

- (1) Hold down  button and  button simultaneously for 2 seconds while the unit is not operating to enable OPERATION LOCK.

The icon for the locked operation mode blinks.

- (2) Hold down  button and  button simultaneously for 2 seconds again while the unit is not operating to disable OPERATION LOCK.

- The icon for the locked operation mode blinks when  button and  button are held down to enable or disable OPERATION LOCK or  button is pressed during operation while OPERATION LOCK is enabled.
- AIR PURIFYING operation is not available when OPERATION LOCK is enabled in a mode other than FAN mode.

10-14. CIRCULATOR OPERATION (MSZ-RZ25/35/50VU-^[SC1] only)

In case the indoor temperature reaches the setting temperature, the outdoor unit stops and the indoor unit starts FAN operation to circulate the indoor air. The outdoor unit starts operation automatically when the indoor temperature drops below the setting temperature.

When the i-see control mode is ON

In the i-see control mode, the vane's wind direction blows horizontally to resolve the uneven temperature in the space. The left-right airflow direction and the fan speed can be set as desired. The circulator may not operate if there is only small unevenness in the room temperature.

When the i-see control mode is OFF

The setting of fan speed and airflow direction can be changed according to your preference.

- (1) Press CIRCULATOR button during HEAT mode to enable CIRCULATOR operation.
The unit performs FAN operation in case the indoor temperature reaches the setting temperature.
- (2) Set the fan speed and airflow direction.
 - The setting of fan speed and airflow direction is common for HEAT and CIRCULATOR operation.
 - Ventilation starts at Low fan speed in case AUTO fan speed is selected.
- (3) Press again to cancel CIRCULATOR operation.

NOTE:

CIRCULATOR operation doesn't work in the following situation.

- AUTO mode (Auto change over) is selected.
- Defrosting is being done.
- Indoor unit is connected to multi type outdoor unit. Although received sound will be heard from the indoor unit and  mark is displayed on remote controller when CIRCULATOR button is pushed, CIRCULATOR operation doesn't work in multi connection.

When the i-see control mode is ON

- FAN operation may make you feel cold wind. Reduce the FAN speed avoid the wind if you feel uncomfortable with cold wind.
- In the i-see control mode, the circulator may not operate depending on the height from the indoor unit to the ceiling or the size of the room.
- The fan speed and the airflow direction can be set with the i-see control mode OFF.

When the i-see control mode is OFF

- FAN operation may make you feel cold wind. Reduce the FAN speed or adjust the airflow direction avoid the wind if you feel uncomfortable with cold wind.

10-15. DRIVE MODE SELECTOR**1. How to set DRIVE mode selector**

- (1) Select a desired mode from WIDE ROOM, ECO, or QUIET.
- (2) Press DRIVE button during COOL and HEAT mode to activate the DRIVE mode.
- (3) Press DRIVE button several times to cancel the DRIVE MODE.



The details of each mode are as follows:

WIDE ROOM

Increases air volume and delivers airflow to a longer distance, reducing temperature unevenness in the room.

QUIET

- Decreases air volume and lowers the operating sound level of the unit.

ECO

- Suppresses a maximum capacity and operates efficiently without an excessive power consumption even when a room temperature suddenly changes.

NOTE:

- WIDE ROOM mode increases operating sound level due to the air volume increase.
- QUIET mode and ECO mode can affect heating and cooling performance.
- ECO mode cannot be activated when connected to a multi-system outdoor unit.
- Cancel the mode if you feel uncomfortable after setting.

10-16. ECONO COOL OPERATION (MSZ-RZ25/35/50VU - [E1] only)

Swing airflow (change of airflow) makes you feel cooler than stationary airflow.

The set temperature and the airflow direction are automatically changed by the microprocessor. It is possible to perform cooling operation with keeping comfort. As a result energy can be saved.

- (1) Press  button during COOL mode to start ECONO COOL operation.

The unit performs swing operation vertically in various cycles according to the temperature airflow.

- (2) Press  button again to cancel ECONO COOL operation.

- ECONO COOL operation is also cancelled when the VANE button is pressed.

10-17. LOW NOISE MODE OPERATION

LOW NOISE MODE operation decreases the noise level of the outdoor unit.
 LOW NOISE MODE operation has 2 modes. The operation in Mode 2 is quieter than Mode 1.

- (1) Press [LOW NOISE MODE] button during operation to select the operation mode.
 Pressing the button changes the mode in the following sequence.



The details of each mode are as follows:

LOW NOISE MODE 1

- It will be quieter than the normal operation.

LOW NOISE MODE 2

- It will be quieter than the operation in Mode 1.
- The operation indicator lamp dims.

- (2) To cancel the LOW NOISE MODE operation, press [LOW NOISE MODE] button several times.

NOTE:

- The cooling/heating capacity may drop.
- Noise level of the outdoor unit may not change depending on the operating conditions, for example, immediately after start-up of the unit or during the protection operation.
- The fan speed of the indoor unit will not change.
- The operation indicator lamp will be hard to be seen in a bright room.

10-18. EMERGENCY/TEST OPERATION

In the case of test run operation or emergency operation, use the emergency operation switch on the right side of the indoor unit. Emergency operation is available when the remote controller is missing or has failed, or when the batteries in the remote controller are running down. The unit will start and OPERATION INDICATOR lamp will light up.

The first 30 minutes of operation is the test run operation. This operation is for servicing. The indoor fan runs at High speed and the temperature control does not work.

After 30 minutes of test run operation, the system shifts to EMERGENCY COOL/HEAT MODE with a set temperature of 24°C. The fan speed shifts to Med.

The coil frost prevention works even in the test run or the emergency operation.

In the test run or emergency operation, the horizontal vane operates in VANE AUTO (@) mode.

Emergency operation continues until the emergency operation switch is pressed once or twice or the unit receives any signal from the remote controller. In the latter case, normal operation will start.

NOTE: Do not press the emergency operation switch during normal operation.

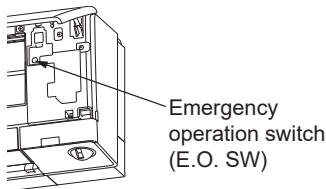

Operation mode	COOL/HEAT
Set temperature	24°C
Fan speed	Med.
Horizontal vane	Auto

The operation mode is indicated by the operation indicator lamp as following

Operation indicator lamp



10-19. 3-MINUTE TIME DELAY OPERATION

When the system turns OFF, compressor will not restart for 3 minutes as 3-minute time delay function operates to protect compressor from overload.

MSZ-RZ25VU MSZ-RZ35VU MSZ-RZ50VU

11-1. CAUTIONS ON TROUBLESHOOTING

1. Before troubleshooting, check the following

- 1) Check the power supply voltage.
- 2) Check the indoor/outdoor connecting wire for miswiring.

2. Take care of the following during servicing

- 1) Before servicing the air conditioner, be sure to turn OFF the main unit first with the remote controller, and then after confirming the horizontal vane is closed, turn OFF the breaker and/or disconnect the power plug.
- 2) Be sure to turn OFF the power supply before removing the front panel, the cabinet, the top panel, and the P.C. board.
- 3) When removing the P.C. board, hold the edge of the board with care NOT to apply stress on the components.
- 4) When connecting or disconnecting the connectors, hold the connector housing. DO NOT pull the lead wires.

<Incorrect>



Lead wiring

<Correct>

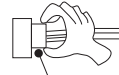

Connector housing

3. Troubleshooting procedure

- 1) Check if the OPERATION INDICATOR lamp on the indoor unit is blinking ON and OFF to indicate an abnormality. To make sure, check how many times the OPERATION INDICATOR lamp is blinking ON and OFF before starting service work.
- 2) Before servicing, verify that all connectors and terminals are connected properly.
- 3) When the electronic control P.C. board seems to be defective, check for disconnection of the copper foil pattern and burnt or discolored components.
- 4) When troubleshooting, Refer to 11-2, 11-3 and 11-4.

4. How to replace batteries

Weak batteries may cause the remote controller malfunction.

In this case, replace the batteries to operate the remote controller normally.

- ① Remove the front lid and insert batteries.

Then reattach the front lid.

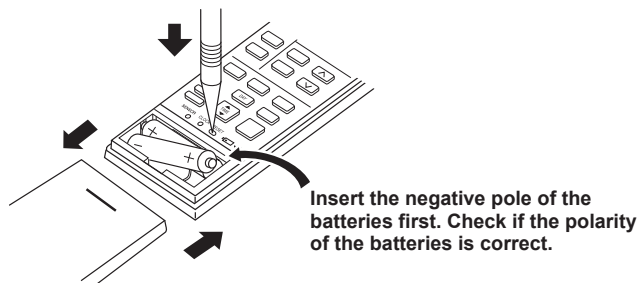

- ② Press RESET button with a fine-tipped object, and then use the remote controller.

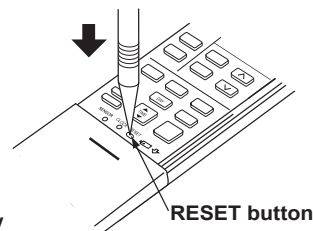

NOTE: 1. If RESET button is not pressed, the remote controller may not operate correctly.

2. This remote controller has a circuit to automatically reset the microprocessor when batteries are replaced.

This function is equipped to prevent the microprocessor from malfunctioning due to the voltage drop caused by the battery replacement.

3. Do not use the leaking batteries.

11-2. FAILURE MODE RECALL FUNCTION

Outline of the function

This air conditioner can memorize the abnormal condition which has occurred once.

Even though LED indication listed on the troubleshooting check table (11-4.) disappears, the memorized failure details can be recalled.

1. Flow chart of failure mode recall function for the indoor/outdoor unit

NOTE: The indoor unit does not operate by smartphone, refer to 11-3.2. "Check of Wi-Fi module".

MSZ-RZ25/35/50VU - [E1] MSZ-RZ25/35/50VU - [SC1]

Operational procedure

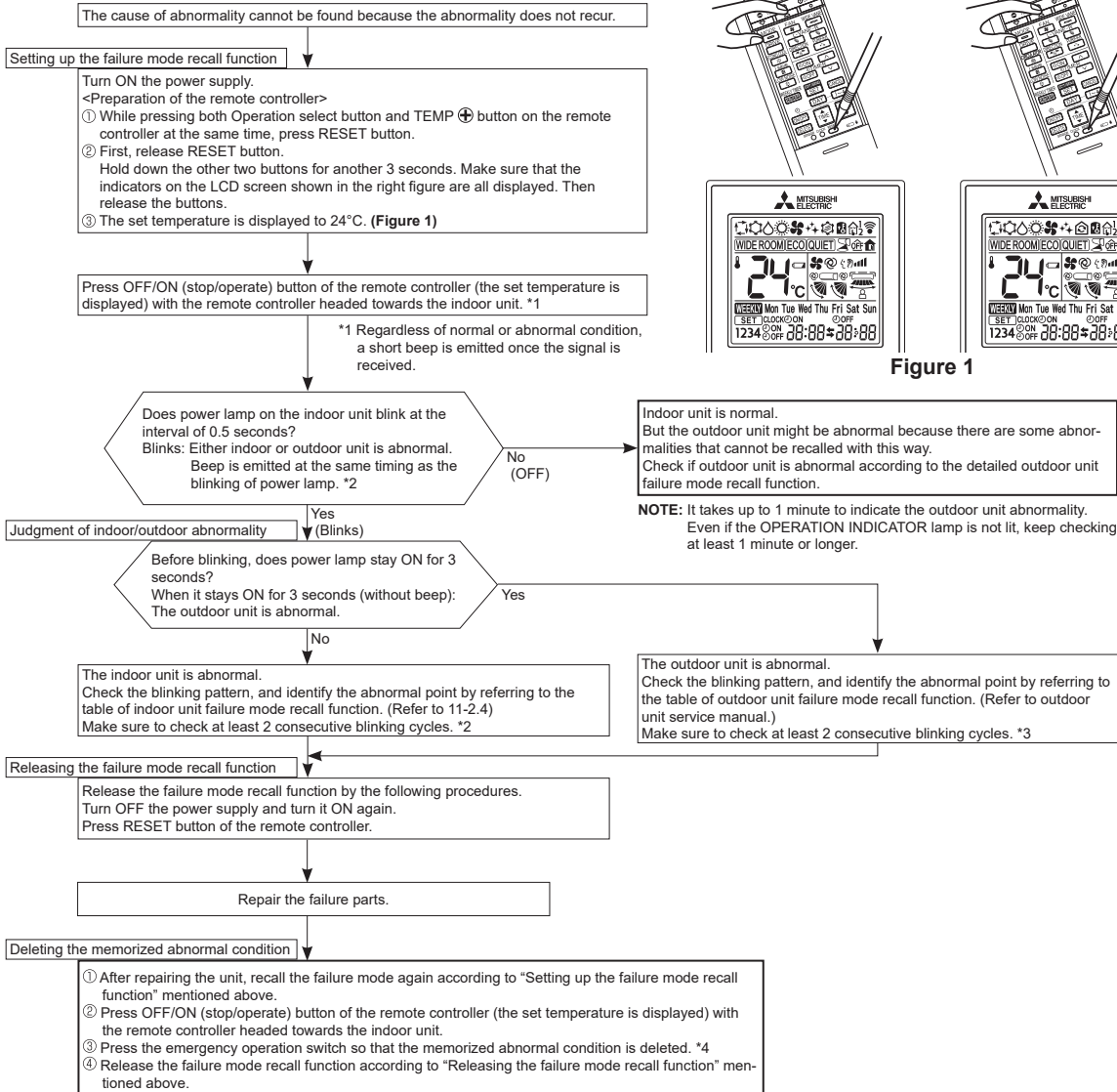

NOTE: 1. Make sure to release the failure mode recall function after it is set up, otherwise the unit cannot operate properly.
 2. If the abnormal condition is not deleted from the memory, the last abnormal condition is kept memorized.

*2. Blinking pattern when the indoor unit is abnormal:

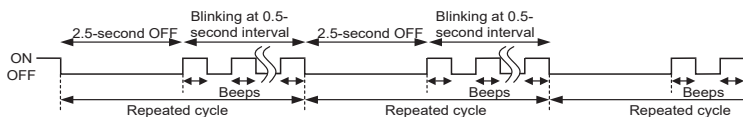

*3. Blinking pattern when the outdoor unit is abnormal:

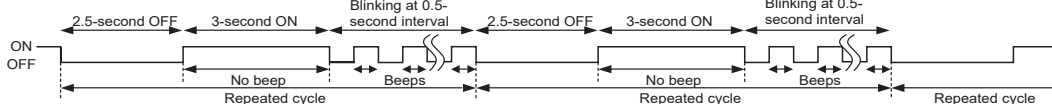

*4. The information regarding whether the connected outdoor unit is a low-standby-power model or a non-low-standby-power model will also be initialized. (Default= compatible with a low-standby-power model)

2. Flow chart of AIR PURIFYING power failure mode and i-see SENSOR failure mode recall function

Operational procedure

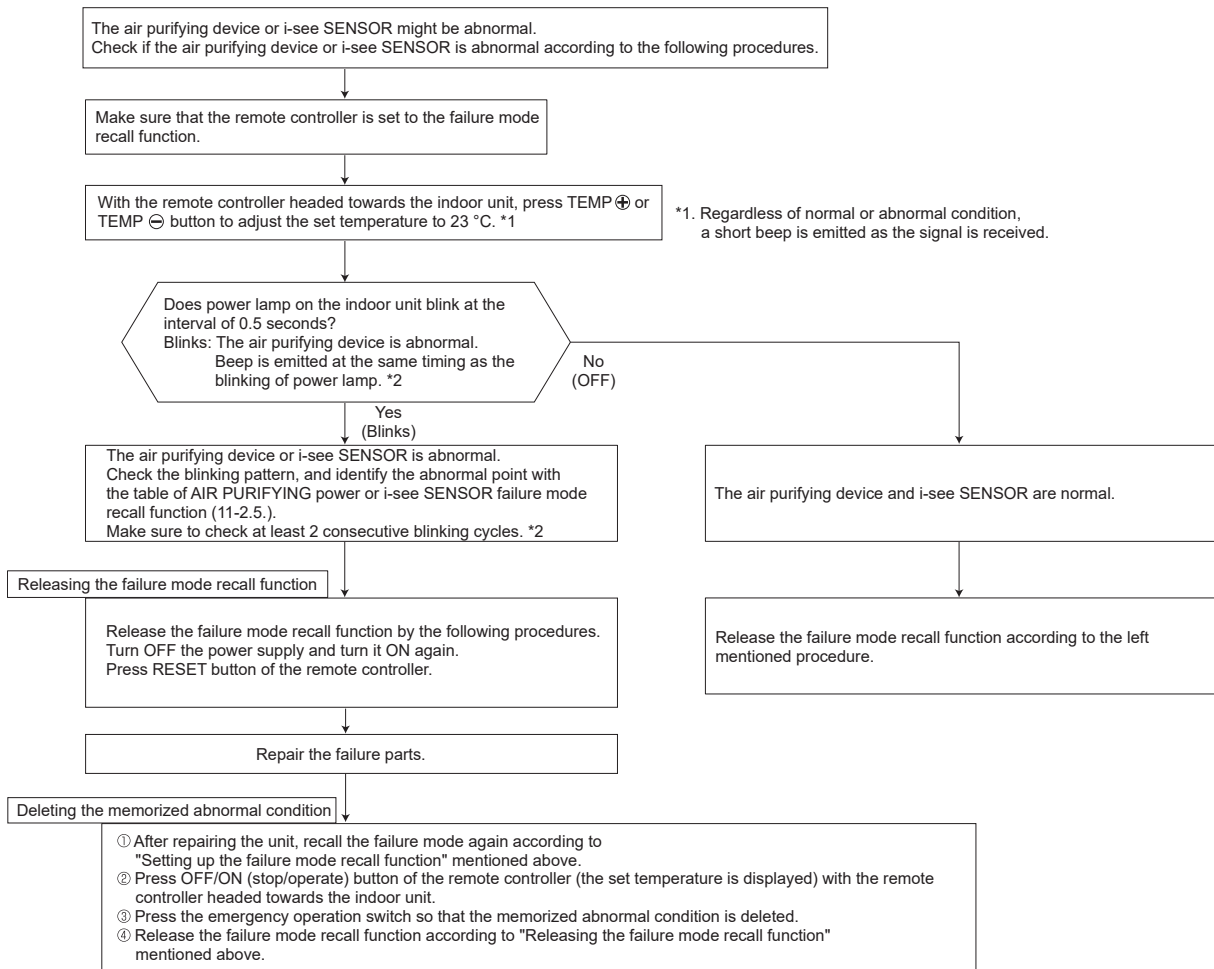

NOTE 1. Make sure to release the failure mode recall function after it is set up, otherwise the unit cannot operate properly.
2. If the abnormal condition is not deleted from the memory, the last abnormal condition is kept memorized.

*2. Blinking pattern when the air purifying device is abnormal:

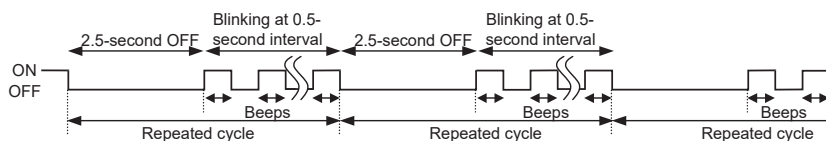

3. AIR PURIFYING power operation check

AIR PURIFYING power operation goes ON when PURIFIER button on the remote controller is pressed with any set temperature displayed during failure mode recall function. Check the operation display section of the remote controller to confirm that AIR PURIFYING power operation is activated. While air purifying lamp stays OFF, it means normal. Blinking air purifying lamp means abnormal, the AIR PURIFYING power operation is not conducted.

AIR PURIFYING lamp	Remedy
Continuously blinking	Follow "Check of AIR PURIFYING power" to identify the error. (Refer to 11-6.㉔.)
2-time blink	AIR PURIFYING power control circuit on the indoor electronic control P.C. board is out of order. (Refer to 11-6.㉔.)

NOTE: Perform the above mentioned check with the front panel closed. The interlock switch (Air purifying device) works by opening front panel and the AIR PURIFYING power is cut.



4. Table of indoor unit failure mode recall function (When recalled at a set temperature of 24°C)

Power lamp	Abnormal point (Failure mode)	Condition	Remedy
Not lit	Normal	—	—
1-time blink every 0.5-second	Room temperature thermistor	The room temperature thermistor short or open circuit is detected every 8 seconds during operation.	Refer to the characteristics of the room temperature thermistor (11-7.).
2-time blink 2.5-second OFF	Indoor coil thermistor	The indoor coil thermistor short or open circuit is detected every 8 seconds during operation.	Refer to the characteristics of the main indoor coil thermistor, the sub indoor coil thermistor (11-7.).
3-time blink 2.5-second OFF	Serial signal	The serial signal from outdoor unit is not received for a maximum of 6 minutes.	Refer to 11-6.④ “How to check miswiring and serial signal error”.
7-time blink 2.5-second OFF	Indoor/Outdoor refrigerant mismatch	Mismatch of refrigerant information between indoor and outdoor units	Connect the correct combination of indoor unit and outdoor unit.
11-time blink 2.5-second OFF	Indoor fan motor	The rotational frequency feedback signal is not emitted for 12 seconds after the indoor fan motor is operated	Refer to 11-6.④ “Check of indoor fan motor”.
12-time blink 2.5-second OFF	Indoor control system	It cannot properly read data in the nonvolatile memory of the indoor electronic control P.C. board.	Replace the indoor electronic control P.C. board.

NOTE: Blinking patterns of this mode differ from the ones of TROUBLESHOOTING CHECK TABLE (11-4.).

5. Table of indoor unit failure mode recall function (When recalled at a set temperature of 23°C)

Table of AIR PURIFYING power failure mode recall function

Power lamp	Abnormal point (Failure mode)	Condition	Remedy
1-time blink	AIR PURIFYING power control	When AIR PURIFYING power cannot be turned OFF even if the AIR PURIFYING operation is turned OFF with the remote controller.	Refer to 11-6.⑤ “Check of AIR PURIFYING power”.
2-time blink	Electrode (Spark discharge)	When the voltage between CN1T1 ③(+) and ②(GND) on the electronic P.C. board falls below 1.3 V (spark discharge judgment voltage).	
3-time blink	Electrode (Abnormal electric discharge error 1)	When the voltage between CN1T1 ③(+) and ②(GND) on the electronic P.C. board falls by 1.2 V below the normal voltage value (2.5 V).	
4-time blink	Electrode (Abnormal electric discharge error 2)	When the voltage between CN1T1 ③(+) and ②(GND) on the electronic P.C. board falls significantly. (0.4 V / 0.5 ms)	
5-time blink	AIR PURIFYING power	When the voltage between CN1T1 ③(+) and ②(GND) on the electronic P.C. board rises above 3 V.	

NOTE 1: Blinking patterns of this mode differ from the ones of TROUBLESHOOTING CHECK TABLE (11-4.).

NOTE 2: As soon as an abnormality is detected, AIR PURIFYING power goes OFF, therefore measuring instrument which records the voltage wave is required in order to perform the above mentioned voltage measurement.

Table of i-see SENSOR failure mode recall function

Power lamp	Abnormal point (Failure mode)	Condition	Remedy
6-time blink	i-see SENSOR	Poor contact in i-see SENSOR wiring failure in loading corrected data of i-see SENSOR	Check for disconnection of the connectors.

NOTE: Blinking patterns of this mode differ from the ones of TROUBLESHOOTING CHECK TABLE (11-4.).

6. Operation check on i-see SENSOR

While recalling the failure details, set the temperature to 19°C to perform the simple check on the i-see SENSOR.

Place your hand over the i-see SENSOR, and the buzzer will beep at 1 second intervals. (Normal detection temperature range is 34 to 39°C.)

If the buzzer does not beep, check for disconnection of the connectors.

Set the temperature to 24°C to exit the simple check mode on the i-see SENSOR.

11-3. INSTRUCTION OF TROUBLESHOOTING

1. Check of the unit.

*1 "Test Run operation" means the operation within 30 minutes after the emergency operation switch is pressed.

*2 There is possibility that diesel explosion may occur due to the air mixed in the refrigerant circuit.
 First, ensure that there are no leakage points on the valves, flare connections, etc. that allow the air to flow into the refrigerant circuit, or no blockage points (e.g. clogged or closed valves) in the refrigerant circuit that cause an increase in pressure.
 If there is no abnormal point like above and the system operates cooling and heating modes normally, the indoor thermistor might have a problem, resulting in false detection.
 Check both the indoor coil thermistor and the room temperature thermistor, and replace faulty thermistor(s), if any.

NOTE: Do not start the operation again without repair to prevent hazards.

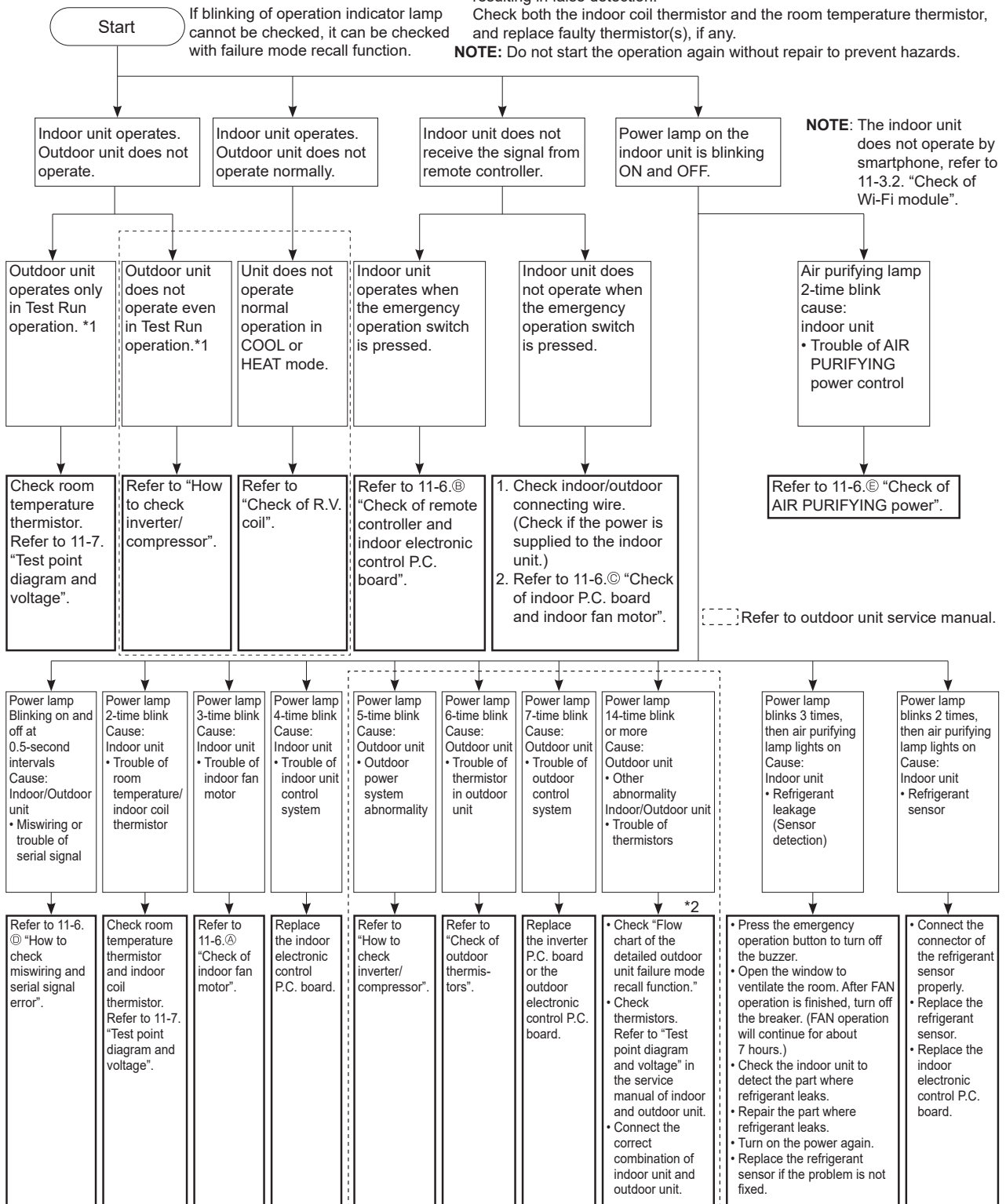

2. Check of Wi-Fi module

Follow the procedure below if the air conditioner cannot be monitored or controlled with a device such as a smartphone.

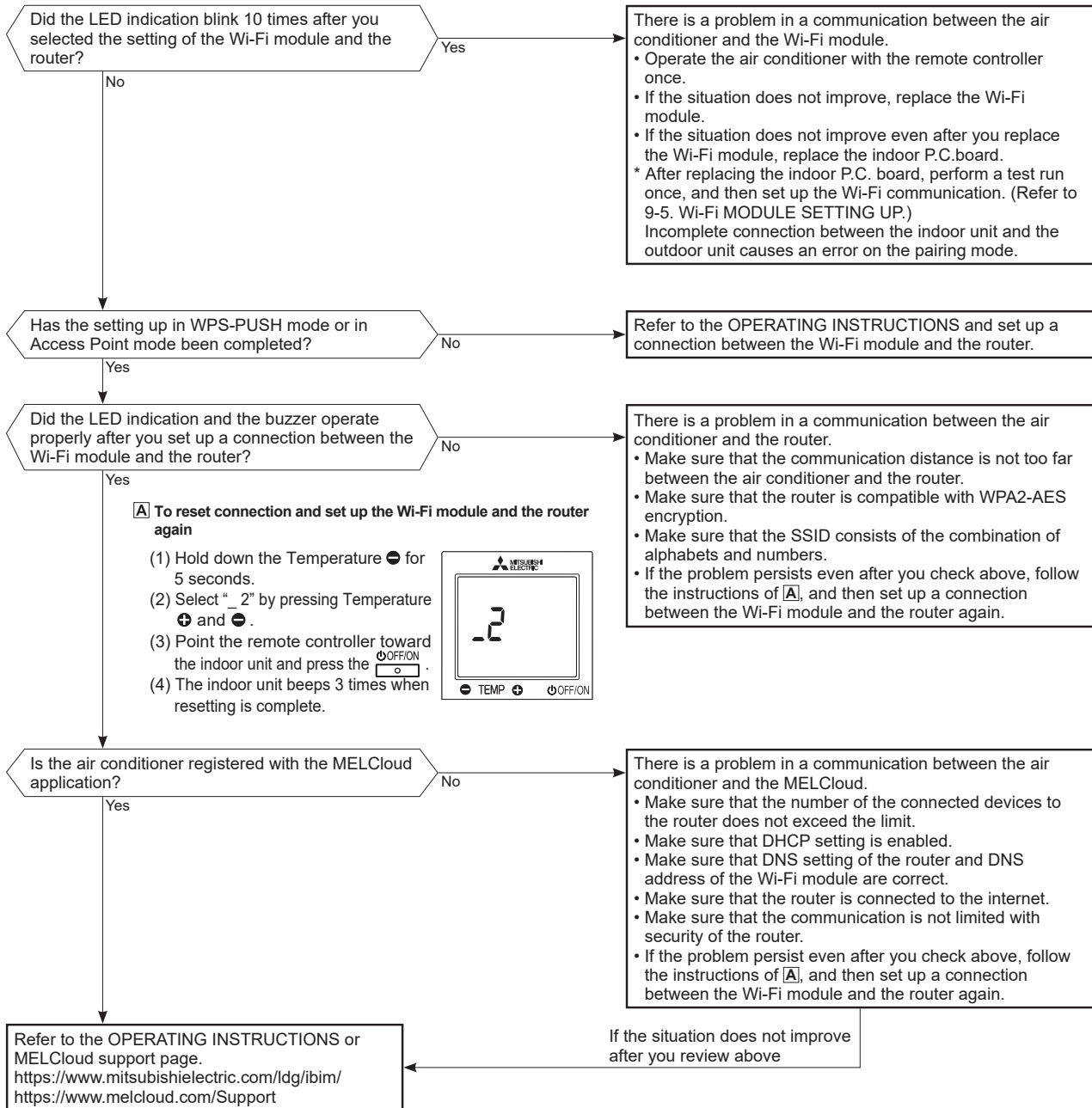

11-4. TROUBLESHOOTING CHECK TABLE

Before taking measures, make sure that the symptom reappears for accurate troubleshooting.

When the indoor unit has started operation and detected an abnormality of the following condition (the first detection after the power ON), the indoor fan motor turns OFF and OPERATION INDICATOR lamp blinks.

- The following indicator applies regardless of shape of the indication.

OPERATION INDICATOR



No.	Abnormal point	Operation indicator lamp	Symptom	Condition	Remedy
1	Miswiring or serial signal	Power lamp blinks. 0.5-second ON ●○●○●○●○ 0.5-second OFF		The serial signal from the outdoor unit is not received for 6 minutes.	• Refer to 11-6.② "How to check miswiring and serial signal error".
2	Indoor coil thermistor Room temperature thermistor	Power lamp blinks. 2-time blink ●○●○●○●○●○●○ 2.5-second OFF		The indoor coil or the room temperature thermistor is short or open circuit.	• Refer to the characteristics of indoor coil thermistor, and the room temperature thermistor (11-7.).
3	Indoor fan motor	Power lamp blinks. 3-time blink ●○●○●○●○●○●○●○ 2.5-second OFF		The rotational frequency feedback signal is not emitted during the indoor fan operation.	• Refer to 11-6.③ "Check of indoor fan motor".
4	Indoor control system	Power lamp blinks. 4-time blink ●○●○●○●○●○●○●○●○ 2.5-second OFF		It cannot properly read data in the nonvolatile memory of the indoor electronic control P.C. board.	• Replace the indoor electronic control P.C. board.
5	Outdoor power system	Power lamp blinks. 5-time blink ●○●○●○●○●○●○●○●○ 2.5-second OFF	Indoor unit and outdoor unit do not operate.	It consecutively occurs 3 times that the compressor stops for overcurrent protection or startup failure protection within 1 minute after startup.	• Refer to "How to check of inverter/compressor". Refer to outdoor unit service manual. • Check the stop valve.
6	Outdoor thermistors	Power lamp blinks. 6-time blink ●○●○●○●○●○●○●○●○●○ 2.5-second OFF		The outdoor thermistors short or open circuit during the compressor operation.	• Refer to "Check of outdoor thermistor". Refer to outdoor unit service manual.
7	Outdoor control system	Power lamp blinks. 7-time blink ●○●○●○●○●○●○●○●○●○●○ 2.5-second OFF		It cannot properly read data in the nonvolatile memory of the inverter P.C. board or the outdoor electronic control P.C. board.	• Replace the inverter P.C. board or the outdoor electronic control P.C. board. Refer to outdoor unit service manual.
8	Other abnormality *1	Power lamp blinks. 14-time blink or more ●○●○●○●○●○●○●○●○●○●○●○●○●○ 2.5-second OFF		An abnormality other than the above is detected. An abnormality of the indoor thermistors, the defrost thermistor or ambient temperature thermistor is detected. Mismatch of refrigerant information between indoor and outdoor units.	• Check the stop valve. • Check the 4-way valve. • Check the abnormality in detail using the failure mode recall function for outdoor unit. • Refer to "TEST POINT DIAGRAM AND VOLTAGE" on the service manual of indoor and outdoor unit for the characteristics of the thermistors. (Do not start the operation again without repair to prevent hazards.) • Connect the correct combination of indoor unit and outdoor unit.
9	Outdoor control system	Power lamp lights up. ●	Outdoor unit does not operate	It cannot properly read data in the nonvolatile memory of the inverter P.C. board or the outdoor electronic control P.C. board.	• Check the blinking pattern of the LED on the inverter P.C. board or the outdoor electronic control P.C. board.
10	Refrigerant sensor	Power lamp blinks 2 times, then Air purifying lamp lights on. Power lamp ●○●○●○●○●○●○ 3.0-second OFF Air purifying lamp ○○●○●○●○●○●○ 3.0-second ON	<ul style="list-style-type: none"> • FAN operation starts, and swing the horizontal vane and vertical vane. • It cannot be controlled by the remote controller. 	The refrigerant sensor mounted on the indoor unit does not work. The refrigerant sensor is not connected properly or the wire is broken.	<ul style="list-style-type: none"> • Connect the connector of the refrigerant sensor properly. • Replace the refrigerant sensor.

*1 Refer to *2 on 11-3. INSTRUCTION OF TROUBLESHOOTING.

11-5. TROUBLESHOOTING CRITERION OF MAIN PARTS
MSZ-RZ25VU MSZ-RZ35VU MSZ-RZ50VU

Part name	Check method and criterion	Figure			
Room temperature thermistor (RT11) Indoor coil thermistor (RT12, RT13)	Measure the resistance with a multimeter. Refer to 11-7. "Test point diagram and voltage", "Indoor electronic control P.C. board", for the chart of thermistor.				
Indoor fan motor (MF)	Check 11-6.Ⓐ "Check of indoor fan motor".				
Vane motor (MV1) (HORIZONTAL)	Measure the resistance between the terminals with a multimeter. (Temperature: 10 - 30°C)				
	<table border="1"> <tr> <td>Color of the lead wire</td> <td>Normal</td> </tr> <tr> <td>RED - BRN</td> <td>262 - 328 Ω</td> </tr> </table>		Color of the lead wire	Normal	RED - BRN
Color of the lead wire	Normal				
RED - BRN	262 - 328 Ω				
Vane motor (MV2) (VERTICAL)	Measure the resistance between the terminals with a multimeter. (Temperature: 10 - 30°C)				
	<table border="1"> <tr> <td>Color of the lead wire</td> <td>Normal</td> </tr> <tr> <td>RED - BRN</td> <td>219 - 273 Ω</td> </tr> </table>		Color of the lead wire	Normal	RED - BRN
Color of the lead wire	Normal				
RED - BRN	219 - 273 Ω				
i-see SENSOR MOTOR (MT)	Measure the resistance between the terminals with a multimeter. (Temperature: 10 - 30°C)				
	<table border="1"> <tr> <td>Color of the lead wire</td> <td>Normal</td> </tr> <tr> <td>RED - BRN</td> <td>262 - 328 Ω</td> </tr> </table>		Color of the lead wire	Normal	RED - BRN
Color of the lead wire	Normal				
RED - BRN	262 - 328 Ω				
AIR PURIFYING power	Check 11-6.Ⓔ.				

11-6. TROUBLESHOOTING FLOW

A Check of indoor fan motor

The indoor fan motor error has occurred, and the indoor fan does not operate.

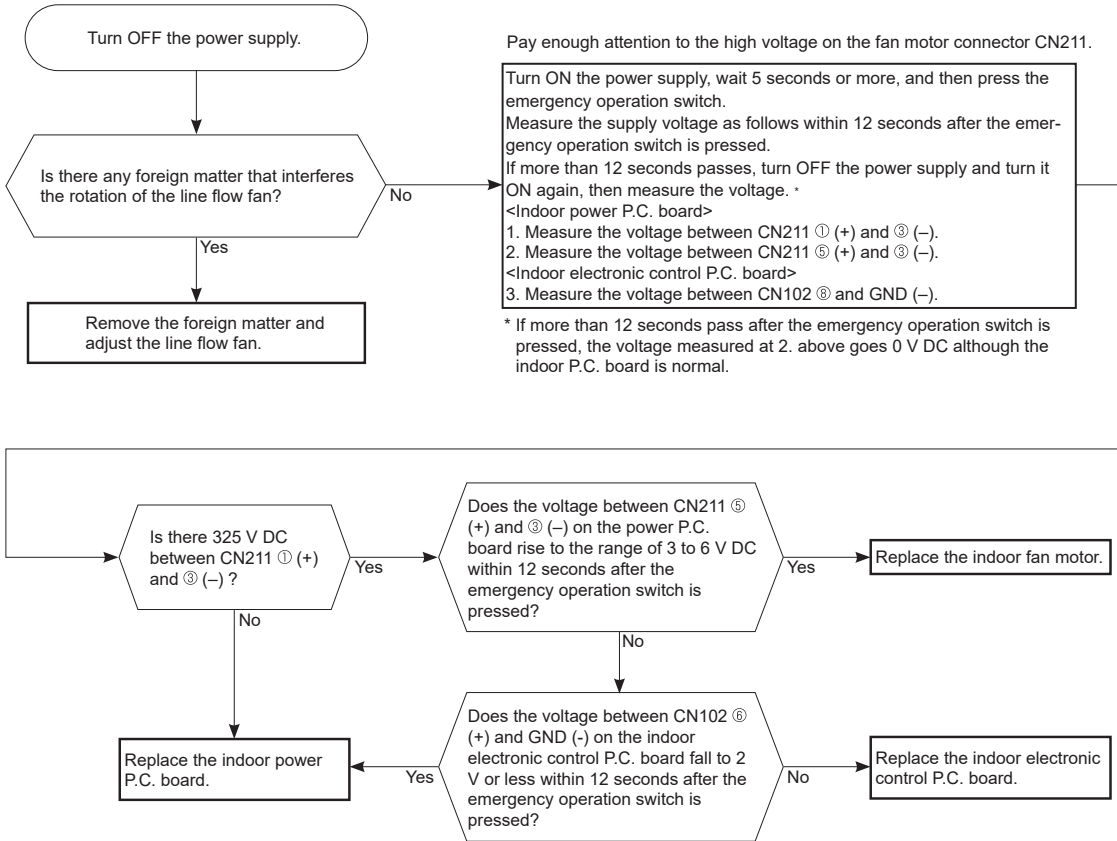

The indoor fan motor error has occurred, and the indoor fan repeats "12-second ON and 30-second OFF" 3 times, and then stops.

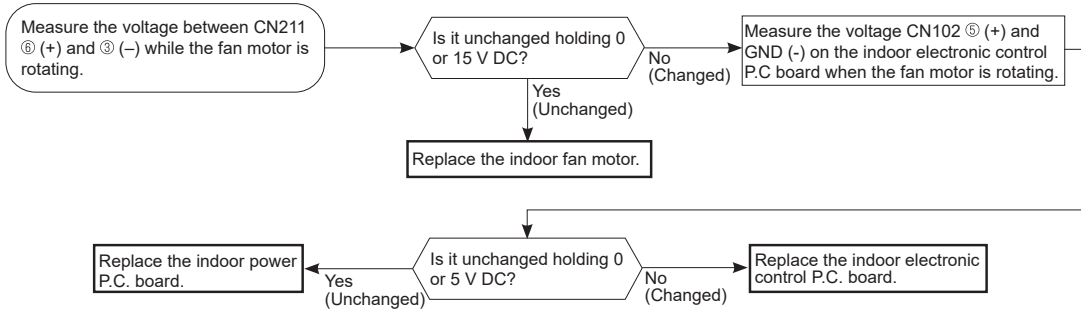

B Check of remote controller and indoor electronic control P.C. board

NOTE: Check if the remote controller is exclusive for this air conditioner.

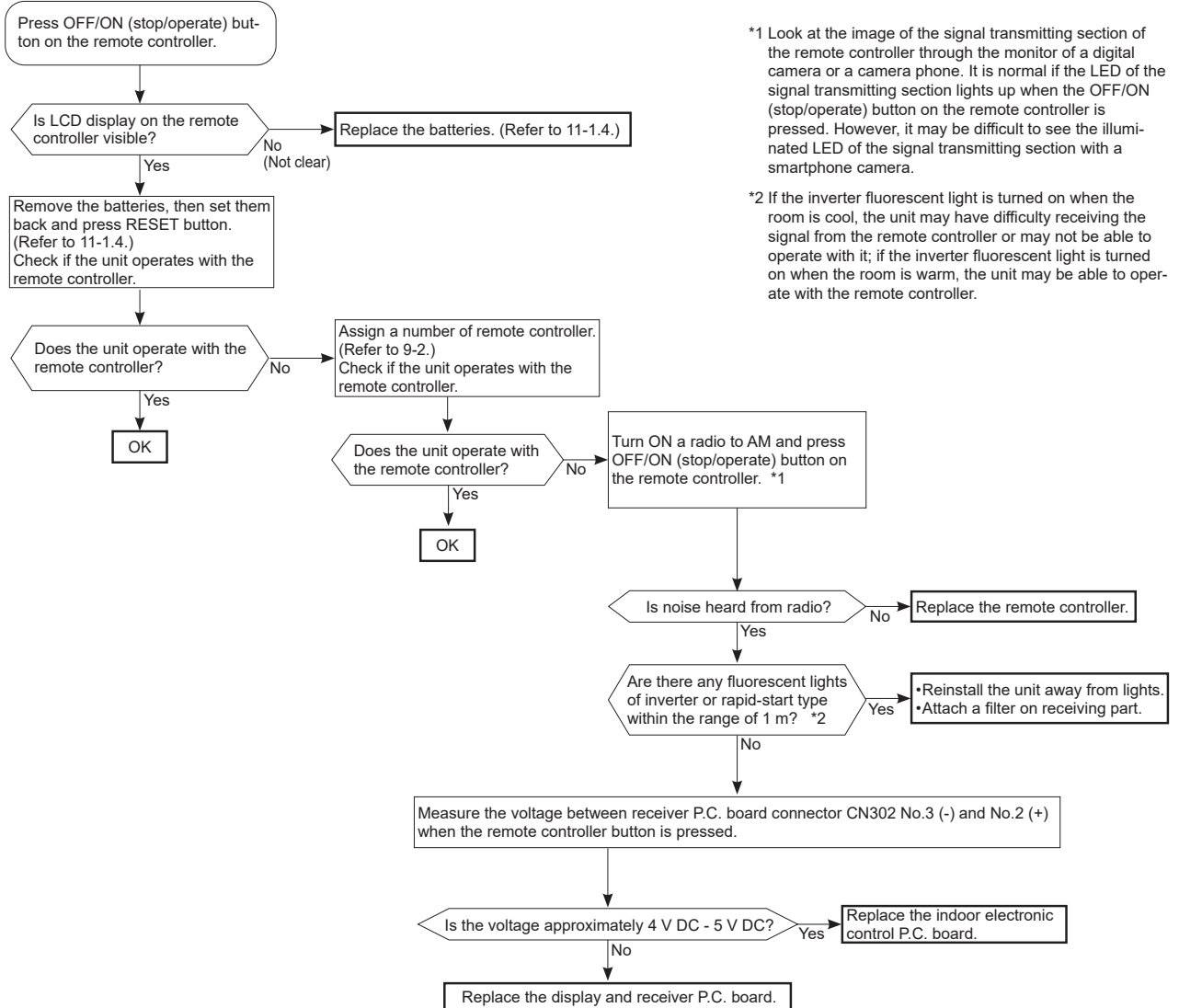

C Check of indoor P.C. board and indoor fan motor

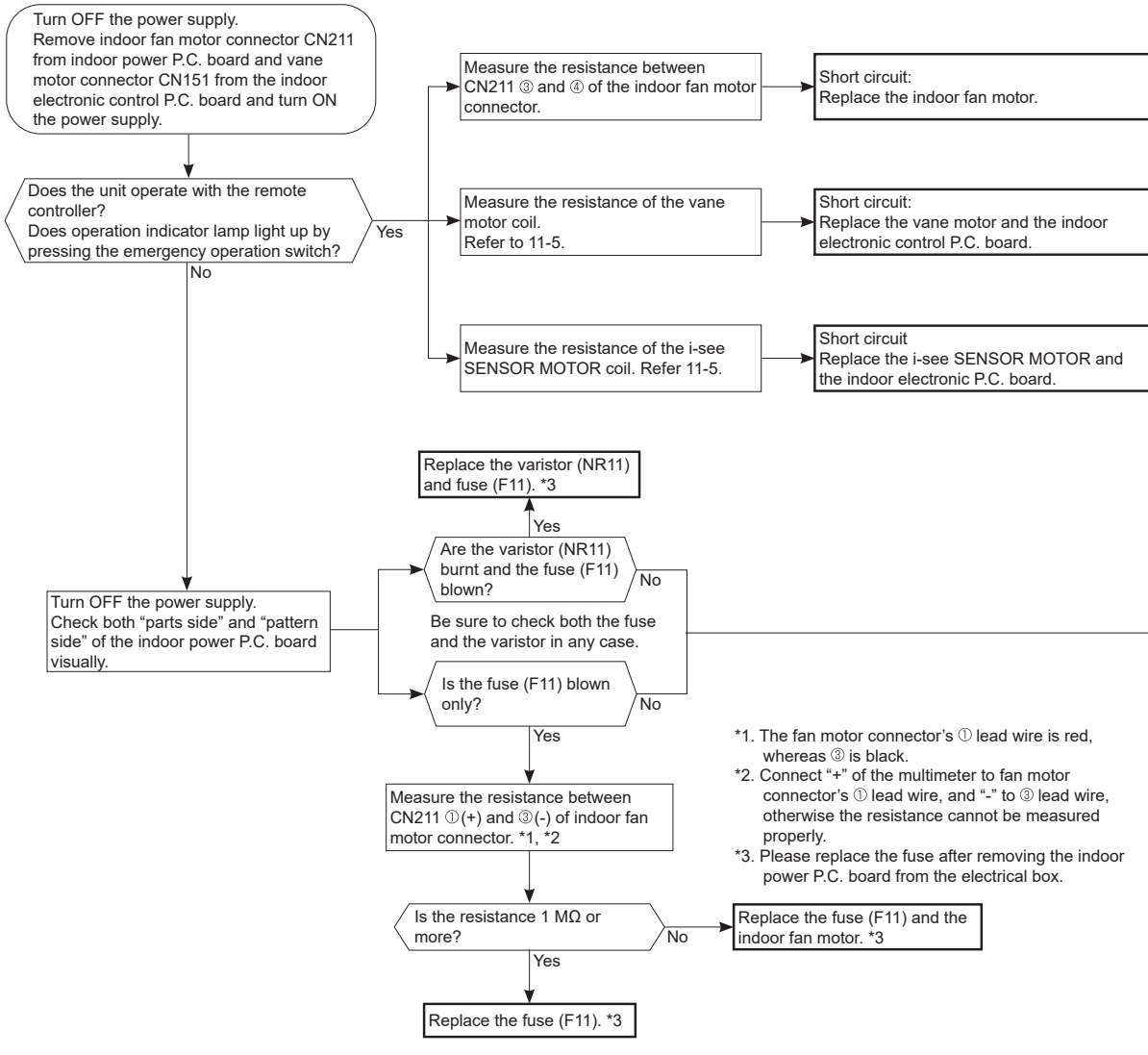

- *1. The fan motor connector's ① lead wire is red, whereas ③ is black.
- *2. Connect "+" of the multimeter to fan motor connector's ① lead wire, and "-" to ③ lead wire, otherwise the resistance cannot be measured properly.
- *3. Please replace the fuse after removing the indoor power P.C. board from the electrical box.

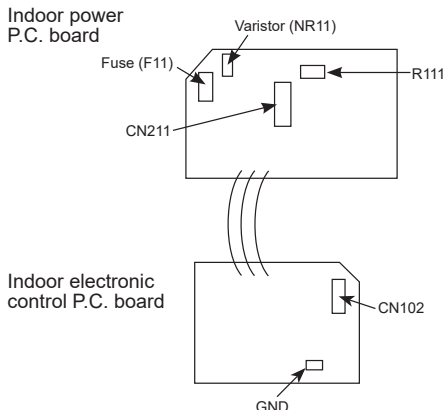
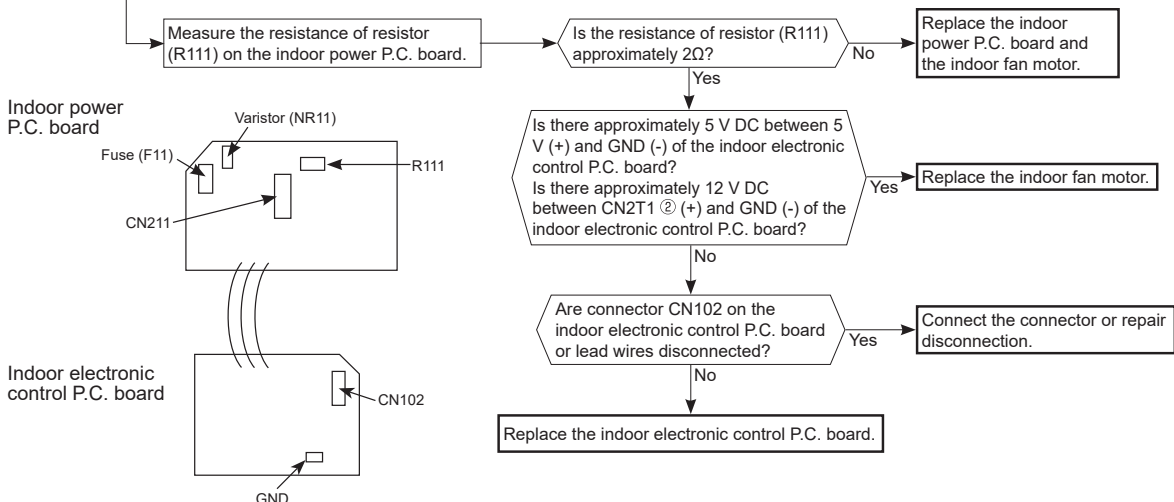

D How to check miswiring and serial signal error

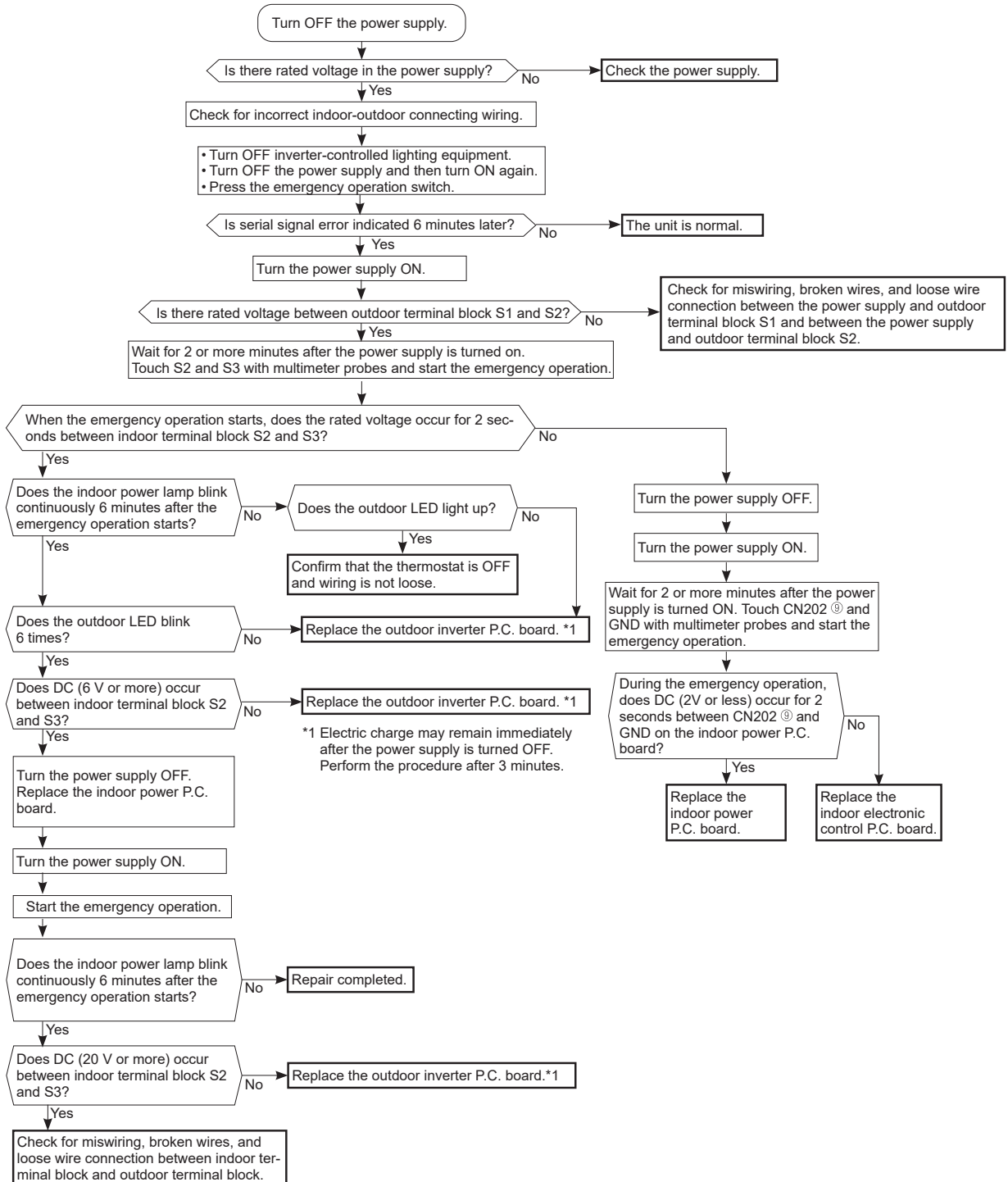

E Check of AIR PURIFYING power

After performing the check, make sure to release the failure mode recall function.

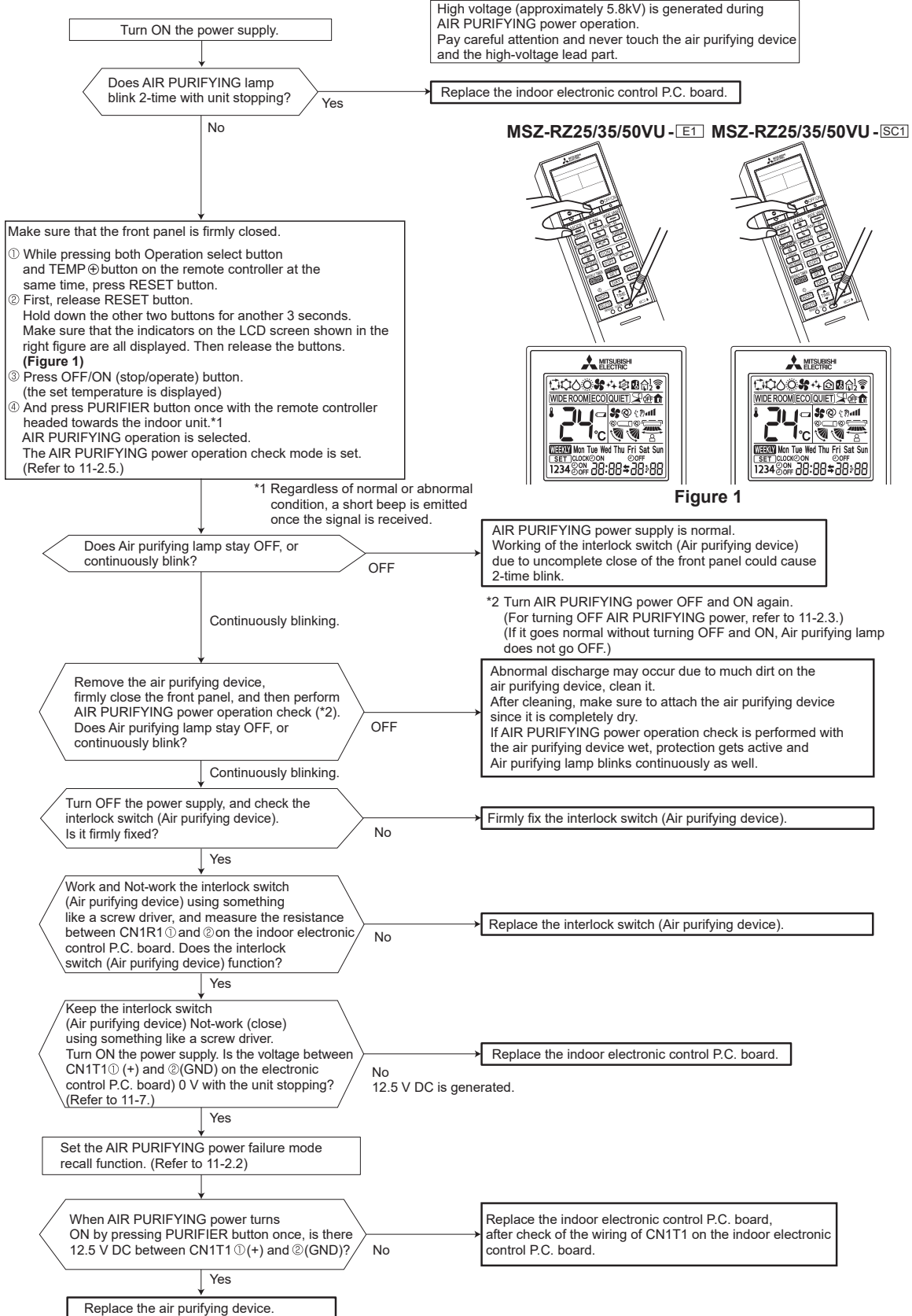

F Electromagnetic noise enters into TV sets or radios

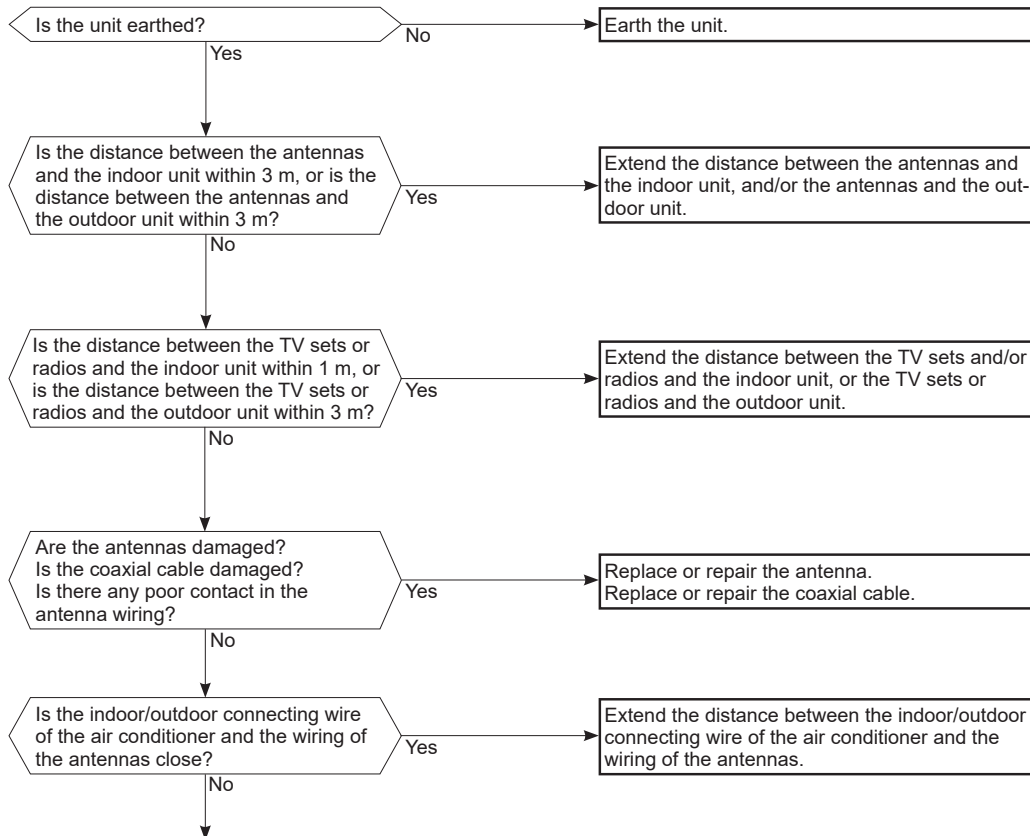

Even if all of the above conditions are fulfilled, the electromagnetic noise may enter, depending on the electric field strength or the installation condition (combination of specific conditions such as antennas or wiring).
Check the following before asking for service.

1. Devices affected by the electromagnetic noise
TV sets, radios (FM/AM broadcast, shortwave)
2. Channel, frequency, broadcast station affected by the electromagnetic noise
3. Channel, frequency, broadcast station unaffected by the electromagnetic noise
4. Layout of:
indoor/outdoor unit of the air conditioner, indoor/outdoor wiring, earth wire, antennas, wiring from antennas, receiver
5. Electric field intensity of the broadcast station affected by the electromagnetic noise
6. Presence or absence of amplifier such as booster
7. Operation condition of air conditioner when the electromagnetic noise enters in
 - 1) Turn OFF the power supply once, and then turn ON the power supply. In this situation, check for the electromagnetic noise.
 - 2) Within 3 minutes after turning ON the power supply, press OFF/ON (stop/operate) button on the remote controller for power ON, and check for the electromagnetic noise.
 - 3) After a short time (3 minutes later after turning ON), the outdoor unit starts running. During operation, check for the electromagnetic noise.
 - 4) Press OFF/ON (stop/operate) button on the remote controller for power OFF, when the outdoor unit stops but the indoor/outdoor communication still runs on. In this situation, check for the electromagnetic noise.

11-7. TEST POINT DIAGRAM AND VOLTAGE

Indoor power P.C. board, Indoor electronic control P.C. board, Display and receiver P.C. board, Switch buzzer P.C. board
MSZ-RZ25VU MSZ-RZ35VU MSZ-RZ50VU

Indoor power P.C. board

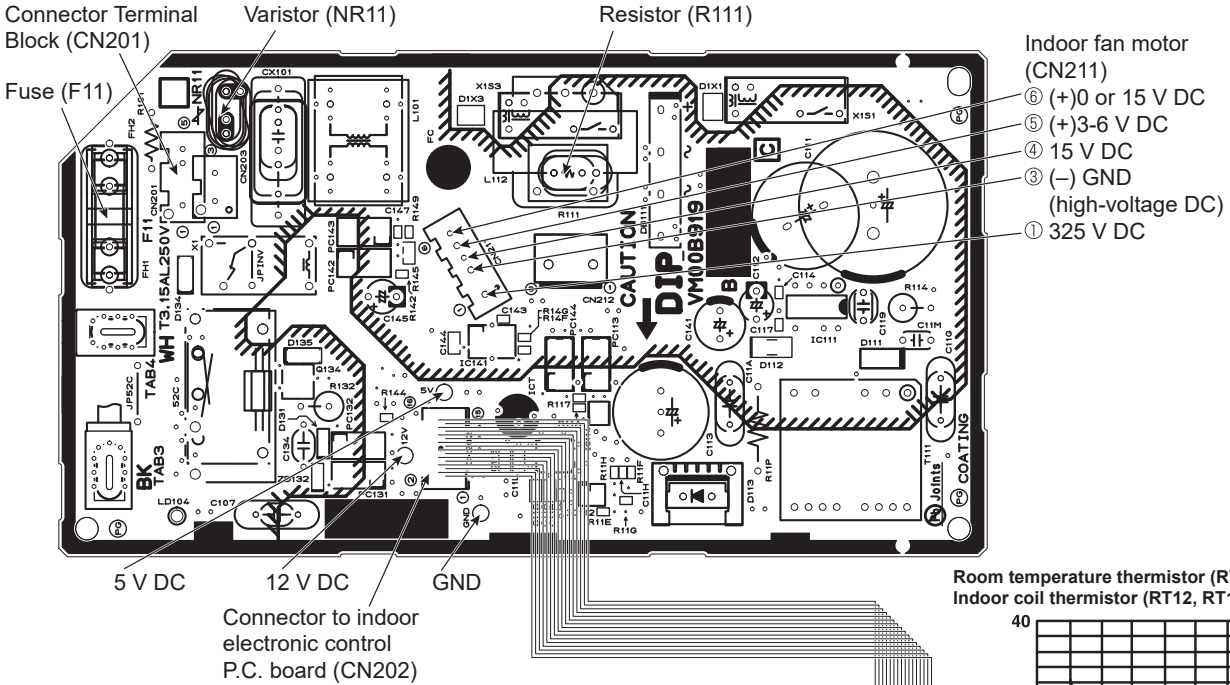

Indoor electronic control P.C. board

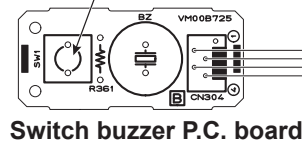
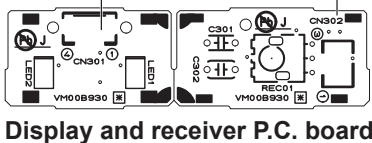
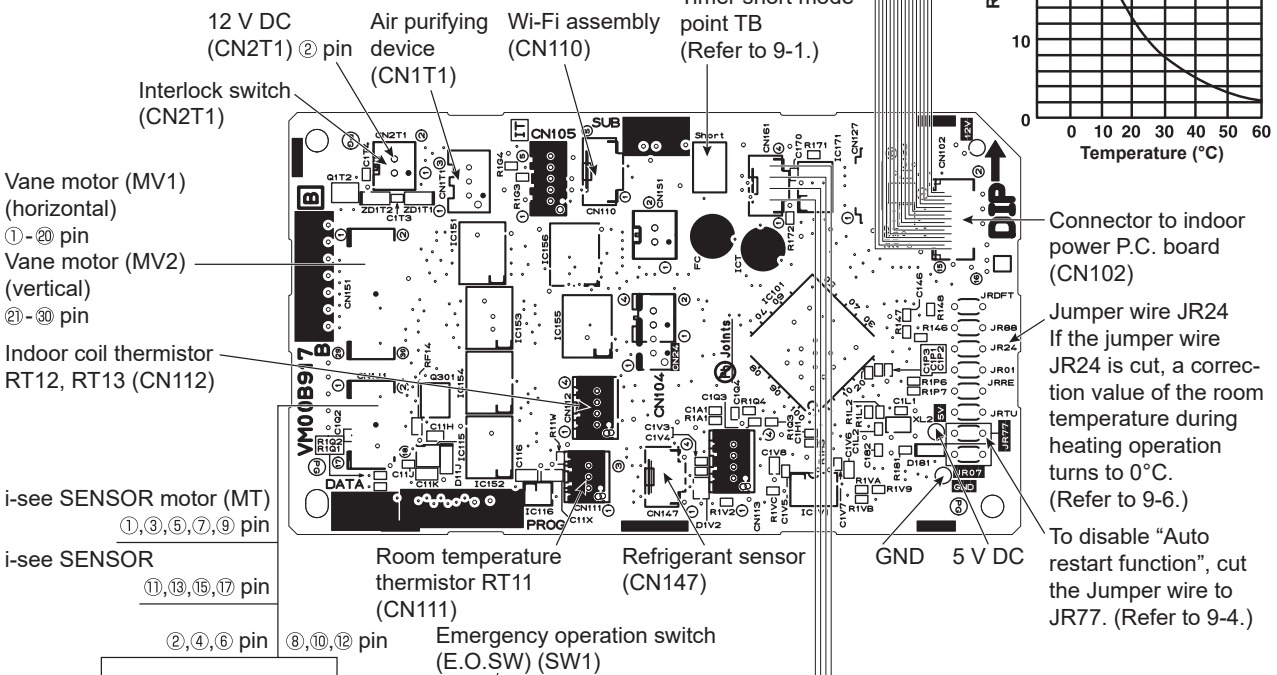

<Detaching method of the terminal with locking mechanism>

The terminal which has the locking mechanism can be detached as shown below.

There are 2 types of the terminal with locking mechanism.

The terminal without locking mechanism can be detached by pulling it out.

Check the shape of the terminal before detaching.

- (1) Slide the sleeve and check if there is a locking lever or not. (2) The terminal with this connector shown below has the locking mechanism.

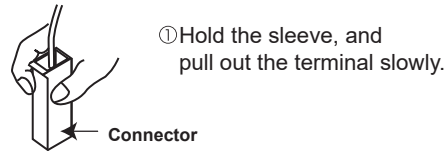
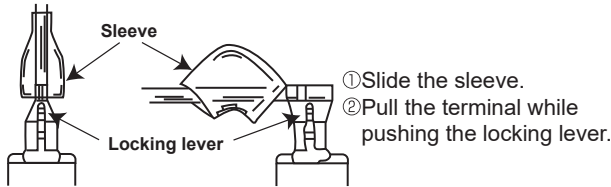

12-1. MSZ-RZ25VU MSZ-RZ35VU MSZ-RZ50VU

NOTE: Turn OFF the power supply before disassembly.

—> : Indicates the visible parts in the photos/figures.
---> : Indicates the invisible parts in the photos/figures.

OPERATING PROCEDURE	PHOTOS/FIGURES
<p>1. Removing the front panel and the panels (U/R/L/F) and horizontal vanes (upper R/L), (lower R/L) Removing the front panel (Photos 1, 2) (1) Lift the front panel until a “click” is heard. (2) Hold the hinges and pull to remove the front panel.</p> <p>Removing the horizontal vanes (upper R/L), (lower R/L)(Photos 3) (1) Unlock the rocks of the horizontal vane upper (R)(2 points). Pull and remove the horizontal vane upper (R) to the side. (2) Remove the horizontal vane upper (L) and horizontal vane lower (R) (L) by the same procedure.</p>	<p>Photo 1</p> <p>Photo 2</p> <p>Photo 3</p>

OPERATING PROCEDURE

How to install the front panel (Photos 1, 2)

- (1) Attach the horizontal vanes (upper R/L) and (lower R/L)
- (2) Install the front panel to the indoor unit.
- (3) Push the locations indicated by the arrows firmly to close the front panel (Figure 1).

Removing the panel (U) (Photo 1)

- (1) Remove the front panel.
- (2) Remove the horizontal vanes (upper R/L), (lower R/L), and the right and left corner boxes.
- (3) Remove the 2 screw caps on the right and left sides of the panel (U), and remove the 2 screws.
- (4) Disengage the catch on the center of the panel (U), and pull it toward you to remove.

How to install the panel (U) (Photo 1)

- (1) Press the center of the panel (U) from the front to snap into place.
- (2) Install the 2 screws in the right and left sides of the panel (U), and cover them with 2 screw caps.

Removing the panel (R) (Photos 1,2,3,4)

- (1) Remove the front panel, the horizontal vanes (upper R/L), (lower R/L), and the corner boxes (R) (L).
- (2) Remove the panel (U).
- (3) Remove the 3 screws of the panel (R), and pull the top of the panel (R) toward you to remove.

How to install the panel (R) (Photo 4)

- (1) Install the panel (R) from the bottom to the top.
- (2) Install the 3 screws in the panel (R).

Removing the panel (L) (Photos 1,2,3,4)

- (1) Remove the front panel, the horizontal vanes (upper R/L), (lower R/L), and the corner boxes (R) (L).
- (2) Remove the panel (U).
- (3) Remove the screw of the panel (L), and pull the top of the panel (L) toward you to remove.

How to install the panel (L) (Photo 4)

- (1) Install the panel (L) from the bottom to the top.
- (2) Install the screw in the panel (L).

Removing the panel (F) (Photo 4)

- (1) Remove the front panel, the horizontal vanes (upper R/L), (lower R/L), and the corner boxes (R) (L).
- (2) Remove the panels (U) (R) (L).
- (3) Remove the Wi-Fi assembly on the right side of the panel (F). Pull out its cable (Refer to section 5).
- (4) Remove the panel (F) from the bottom to the top.

How to install the panel (F)

- (1) Install the panel (F) from the top to the bottom.
- (2) Install the Wi-Fi assembly.

PHOTOS/FIGURES

Figure 1

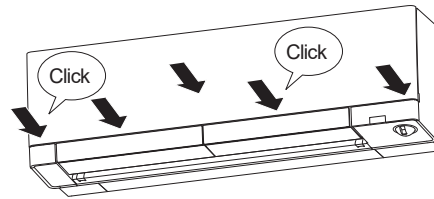
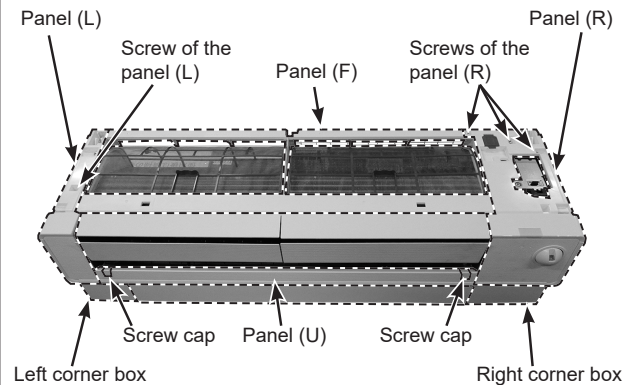
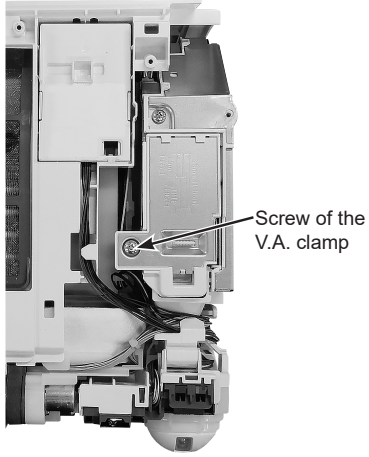
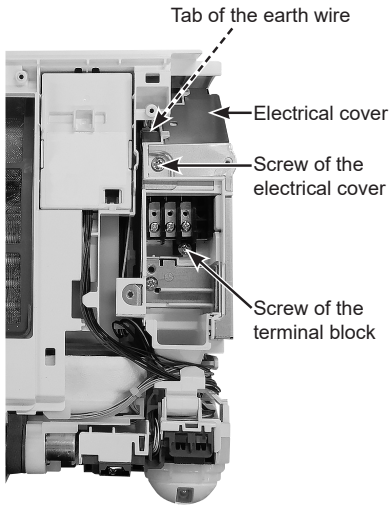
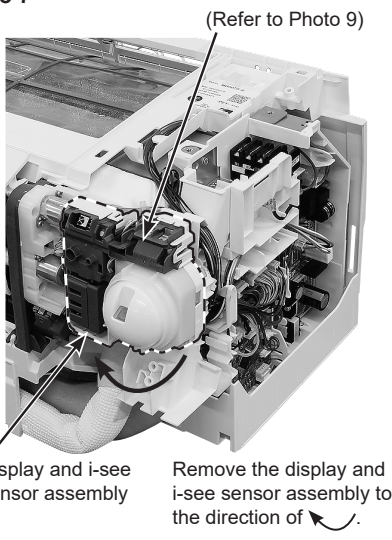
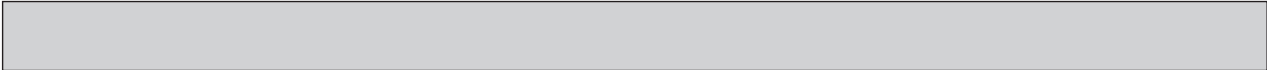

Photo 4





OPERATING PROCEDURE	PHOTOS/FIGURES
<p>2. Removing the indoor electrical box (Photos 5, 6, 7, 8)</p> <p>(1) Remove the front panel, the horizontal vanes (uppler R/L), (lower R/L), the corner boxes (R) (L), and the panels (U) (R) (L) (refer to section 1).</p> <p>(2) Remove the screw of the V.A. clamp, and remove the V.A. clamp (Photo 5).</p> <p>(3) Disconnect the indoor/outdoor connecting wire from the terminal block.</p> <p>(4) Remove the screw of the electrical cover, and remove the electrical cover (Photo 6).</p> <p>(5) Remove the earth wire.</p> <p>(6) Disconnect the following connectors (Photo 8): <Indoor electronic control P.C. board> CN1J1 (Display and i-see sensor assembly) CN147 (Refrigerant sensor)</p> <p>(7) Remove the Display and i-see sensor assembly, and refrigerant sensor assembly (Photo 7).</p> <p>(8) Disconnect the following connector (Photo 8): <Indoor electronic control P.C. board> CN110 (Wi-Fi assembly) CN2T1 [Interlock switch (Air purifying device)] CN161 (Switch buzzer P.C. board) CN211 (Indoor fan motor) CN151 (Vane motors) CN112 (Indoor coil thermistor) CN1T1 (Air purifying device)</p> <p>(9) Remove the electrical box.</p>	<p>Photo 5</p>  <p>Photo 6</p>  <p>Photo 7</p>  <p>(Refer to Photo 9)</p>

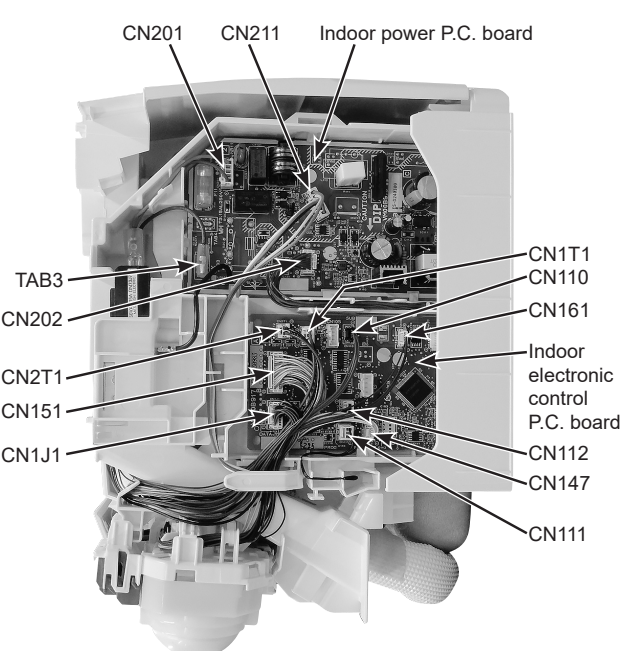

OPERATING PROCEDURE	PHOTOS/FIGURES
<p>3. Removing the indoor electronic control P.C. board, the indoor power P.C. board, the indoor terminal block, and the room temperature thermistor</p> <p>(1) Remove the electrical box (Refer to section 2).</p> <p>Removing the indoor terminal block (Photos 6, 8)</p> <p>(2) Remove the screw of the terminal block. (Photo 6)</p> <p>(3) Disconnect the connectors of the indoor terminal block (TAB3 and CN201).</p> <p>Removing the indoor electronic control P.C. board and the indoor power P.C. board (Photo 8)</p> <p>(2) Disconnect all the connectors on the indoor electronic control P.C. board and the indoor power P.C. board.</p> <p>(3) Remove the indoor electronic control P.C. board and the indoor power P.C. board.</p> <p>Removing the room temperature thermistor (Photo 8)</p> <p>(2) Disconnect the following connector: CN111 (Room temperature thermistor)</p> <p>(3) Remove the room temperature thermistor.</p>	<p>Photo 8 (Enlarged view of the indoor electronic control P.C. board)</p>  <p>The diagram shows an enlarged view of the indoor electronic control P.C. board. It is a complex circuit board with various components and connectors. Labels with arrows point to specific parts: CN201 and CN211 are at the top left; Indoor power P.C. board is at the top right; TAB3 is on the left side; CN202, CN2T1, CN151, and CN1J1 are on the left side of the board; CN1T1, CN110, CN161, Indoor electronic control P.C. board, CN112, CN147, and CN111 are on the right side. The board is populated with numerous integrated circuits, capacitors, and other electronic components.</p>

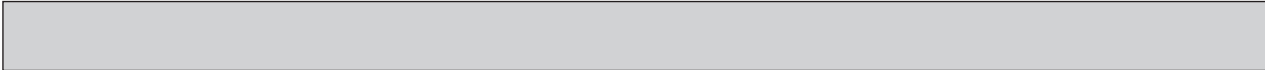

OPERATING PROCEDURE

4. Removing the display and i-see sensor assembly, the refrigerant sensor assembly, the display P.C. board, and the receiver P.C. board (Photo 9).

(1) Remove the display and i-see sensor assembly, and refrigerant sensor assembly (Refer to section 2).

(2) Cut off the cable tie of the lead wires of the display and i-see sensor assembly at the back side of the display cover (Photo 9-2).

(3) Remove the lead wires of the display and i-see sensor assembly from the hooks (Photo 9-2).

(4) Disengage the 3 catches of the display cover, and remove the display cover (Photo 9-1, 2).

(5) Remove the display P.C. board and receiver P.C. board (Photo 9-3).

PHOTOS/FIGURES

Photo 9 (Details of the display and i-see sensor assembly, refrigerant sensor assembly, and board in the display cover)

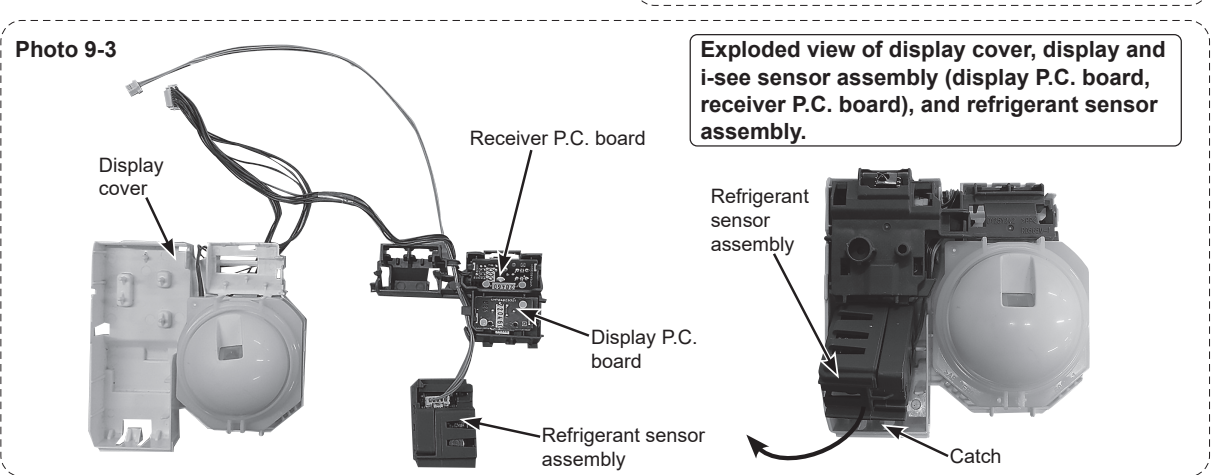
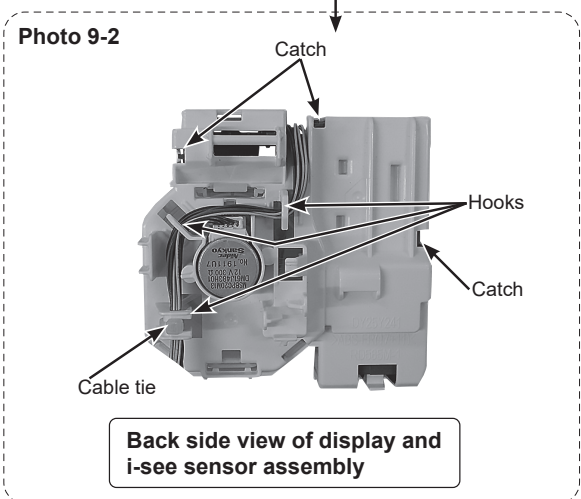
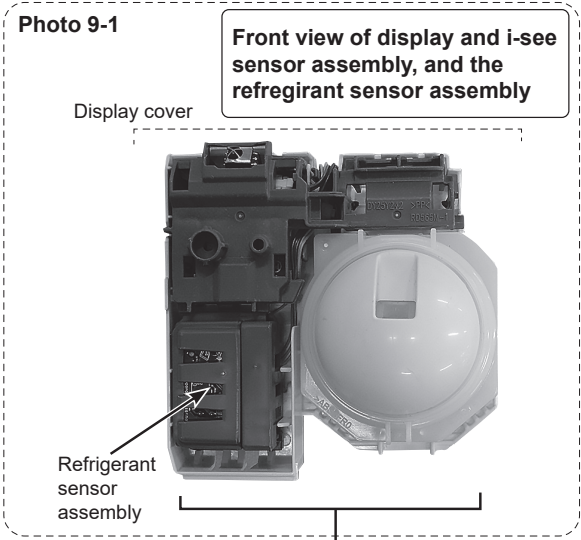

OPERATING PROCEDURE

- (6) Disengage the catches of the display cover, remove the refrigerant sensor assembly from the display cover (Photo 9-3).
- (7) Disengage the catch of the refrigerant sensor cover (Photo 9-4).
- (8) Disconnect the connector of the refrigerant sensor (Photo 9-4).

NOTE: For the refrigerant sensor, replace the refrigerant sensor assembly.

How to install the refrigerant sensor

- (1) Connect the lead wire to the refrigerant sensor. (Figure 2)
- (2) Push the lead wire into the slit so that the refrigerant sensor does not press it.
- (3) Install the refrigerant sensor assembly as shown in the Photo 10.

PHOTOS/FIGURES

Photo 9-4

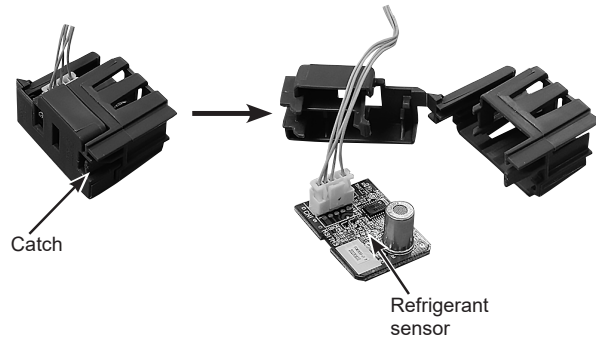

Figure 2

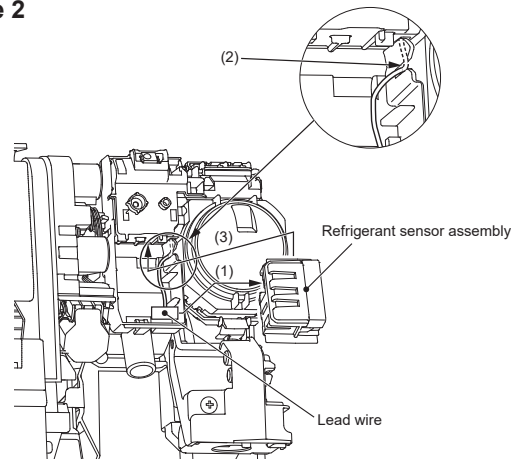
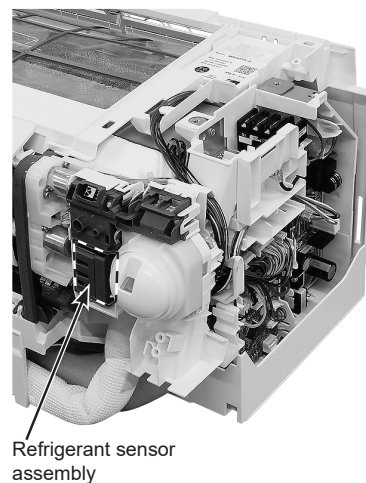
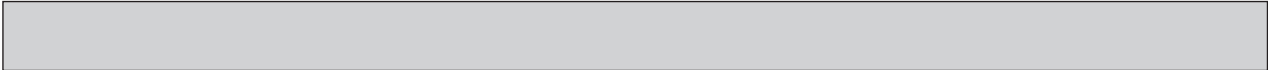
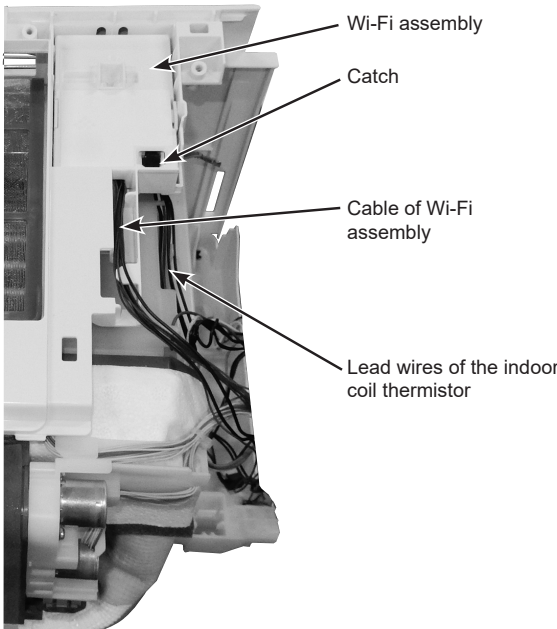



Photo 10





OPERATING PROCEDURE	PHOTOS/FIGURES
<p>5. Removing the Wi-Fi assembly (Photos 3, 11)</p> <ol style="list-style-type: none">(1) Remove the front panel, horizontal vanes (upper R/L), (lower R/L), corner boxes (R) (L), and the panels (U) (L).(2) Remove the indoor/outdoor connecting wire and electrical cover. (Refer to section 2)(3) Disconnect the following connector (Photo 8): <Indoor electronic control P.C. board> CN110 (Wi-Fi assembly) CN2T1 [Interlock switch (Air purifying device)] CN161 (Switch buzzer P.C. board)(4) Remove the cable of Wi-Fi assembly from the PANEL(F).(5) Disengage the catch and remove the Wi-Fi assembly. <p>How to install the Wi-Fi assembly (Photo 11, 12)</p> <ol style="list-style-type: none">(1) Attach the Wi-Fi assembly.(2) Hook the cable of Wi-Fi assembly to the PANEL(F).(3) Connect the connector of CN110 (Wi-Fi assembly) and CN161 (Switch buzzer P.C. board) to the indoor electronic control P.C. board.(4) Install the electrical cover, and install the screw in the electrical cover.(5) Install the V.A. clamp, and install the screw in the V.A. clamp.(6) Install the panel (R) (U).(7) Install the corner boxes (R) (L), and horizontal vanes (upper R/L), (lower R/L).(8) Install the front panel.	<p>Photo 11</p>  <p>Labels for Photo 11:</p> <ul style="list-style-type: none">Wi-Fi assemblyCatchCable of Wi-Fi assemblyLead wires of the indoor coil thermistor <p>Photo 12</p>  <p>Label for Photo 12:</p> <ul style="list-style-type: none">Wi-Fi assembly (Includes Wi-Fi P.C. board, interlock switch, switch buzzer P.C. board)

OPERATING PROCEDURE

6. Removing the horizontal vanes (R)(L) and the horizontal vane motors (R)(L) (Photos 8, 13, 14, 15)

- (1) Remove the front panel, horizontal vanes (upper R/L), (lower R/L), the corner boxes (R) (L), the panels (U) (R) (L), V.A. clamp, the electrical cover, Wi-Fi assembly, the panel (F), and display and i-see sensor assembly.
- (2) Remove the following connector (Photo 8):
<Indoor electronic control P.C. board>
CN151 (Vane motors)
- (3) Pull out the drain hose from the nozzle assembly.
- (4) Pull and remove the nozzle assembly (4 catches)
(Photo 13).
- (5) Cut off the cable tie to secure the lead wires on the right side of the nozzle assembly (Photo 14).

Removing horizontal vane motors (R) (Photo 14)

- (6) Loosen the lead wires, and disconnect the connector of the horizontal vane motors (R).
- (7) Remove the 2 screws of the horizontal vane motors (R).
- (8) Remove the horizontal vane motors (R).

Removing horizontal vane motors (L) (Photo 15)

- (9) Loosen the lead wires, and disconnect the connector of the horizontal vane motors (L).
- (10) Remove the 2 screws of the horizontal vane motors (L).
- (11) Remove the horizontal vane motors (L).

PHOTOS/FIGURES

Photo 13

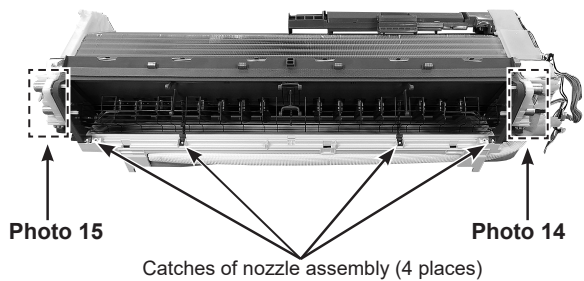

Photo 14

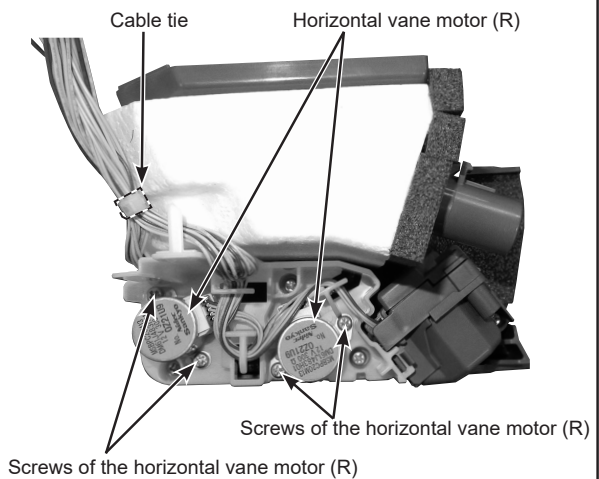
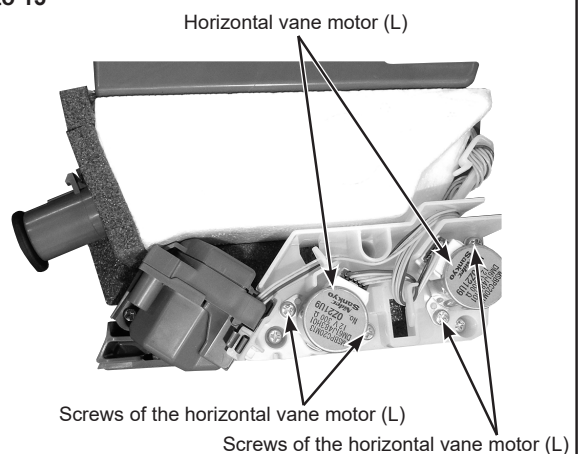
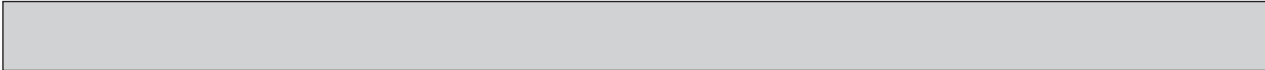

Photo 15





OPERATING PROCEDURE

7. Removing the vertical vane motor units (R) (L) and the vertical vane motors (R) (L)

- (1) Remove the front panel, horizontal vanes (upper R/L) (lower R/L), the corner boxes (R) (L), the panels (U) (R) (L), V.A. clamp, the electrical cover, Wi-Fi assembly, the panel (F), and display and i-see sensor assembly.
- (2) Remove the following connector (Photo 8): <Indoor electronic control P.C. board> CN151 (Vane motors)
- (3) Pull out the drain hose from the nozzle assembly. Pull and remove the nozzle assembly (4 catches) (Photo 13).
- (4) Cut off the cable tie to secure the lead wires on the right side of the nozzle assembly (Photo 16).

Removing the horizontal vane motor unit (R) and the vertical vane motor (R) (Photo 16, 17)

- (5) Remove the 3 screws of the horizontal motor unit (R) indicated in (Photo 16), and remove the lead wires of the vane motors (R).
- (6) Disengage the catch of the horizontal vane motor unit (R), and remove the horizontal vane motor unit (R) (Photo 16).
- (7) Disengage the link of the vertical vane motor unit (R).
- (8) Disengage the catch of the vertical vane motor unit (R), and remove the vertical vane motor (R) from the vertical vane motor unit (R) (Photo 17-1).

PHOTOS/FIGURES

Photo 16

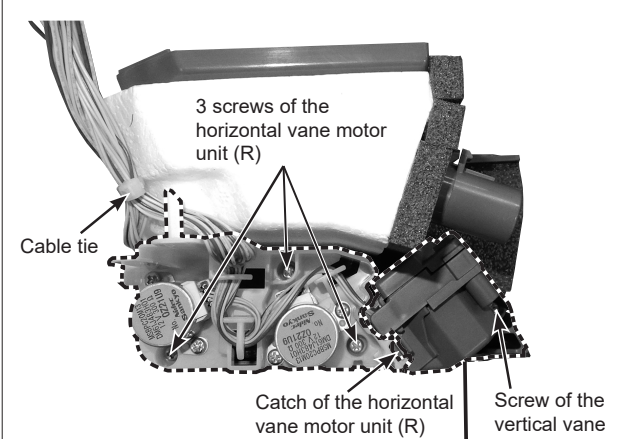

Photo 17

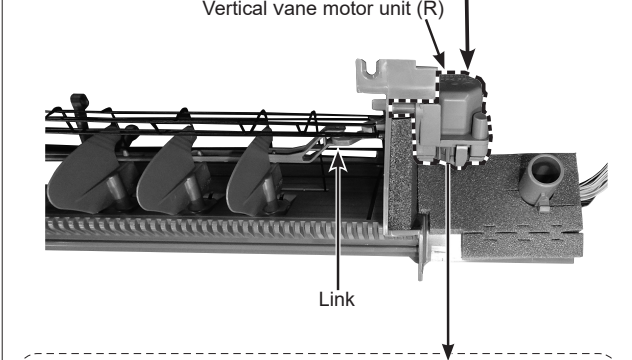
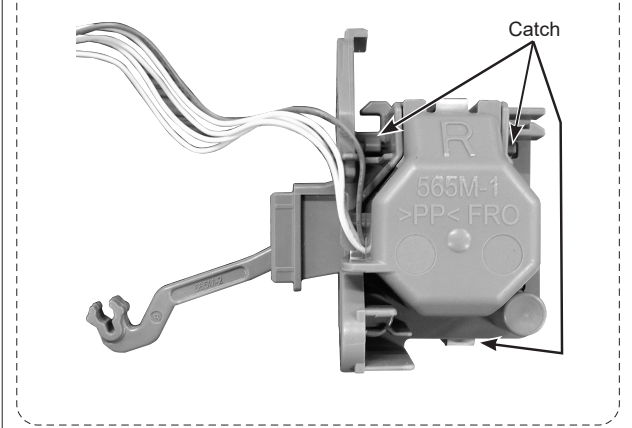

Photo 17-1



OPERATING PROCEDURE

Removing the horizontal vane motor unit (L) and the vane motor (L) (vertical) (Photo 18, 19)

- (9) Remove the 3 screws of the horizontal motor unit (L) indicated in (Photo 18).
- (10) Disengage the catch of the horizontal vane motor unit (L), and remove the horizontal vane motor unit (L). (Photo 18)
- (11) Disengage the link of the vertical vane motor unit (L) (Photo 19-1).
- (12) Disengage the catch of the vertical vane motor unit (L), and remove the vertical vane motor (L) from the vertical vane motor unit (L), (Photo 19-1).

PHOTOS/FIGURES

Photo 19

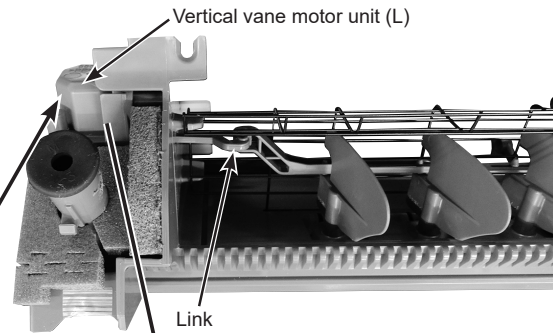

Photo 18

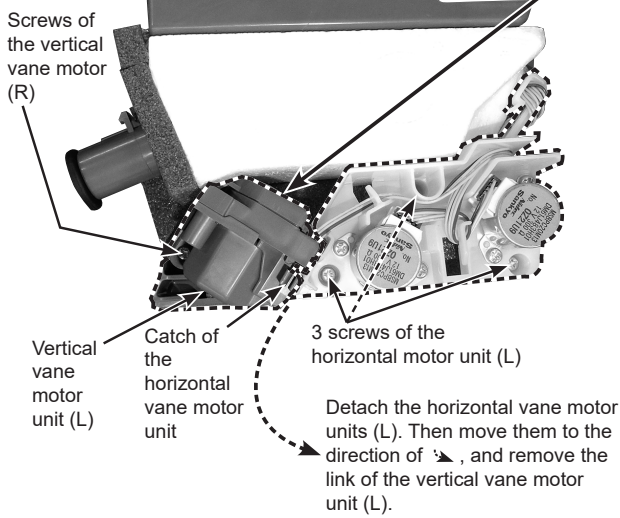

Photo 19-1

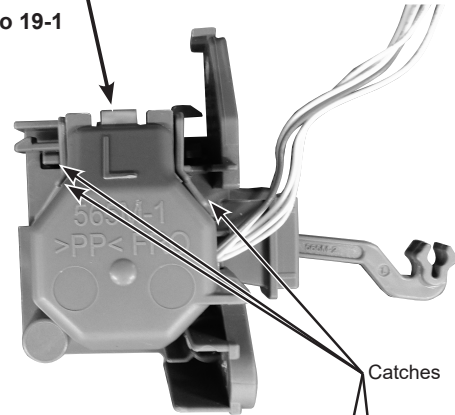
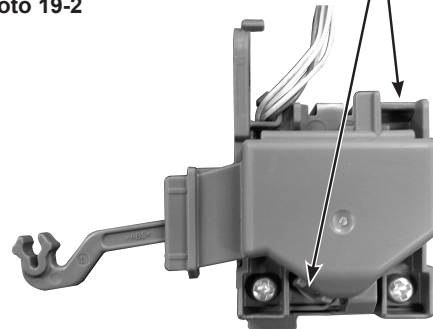
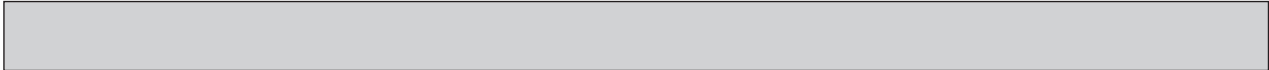

Photo 19-2





OPERATING PROCEDURE

8. Removing the air purifying device (Photo 20)

- (1) Remove the front panel, the horizontal vanes (upper R/L), (lower R/L), the corner boxes (R) (L), the panels (U) (R) (L), V.A. clamp, the electrical cover, Wi-Fi assembly, and the panel (F).
- (2) Disconnect the following connector (Photo 8):
<Indoor electronic control P.C. board>
CN1T1 (Air purifying device)
- (3) Remove the lead wires from the water cover.
- (4) Remove the screw of the air purifying device support. (Photo 22)
- (5) Remove the air purifying device support.

9. Removing the line flow fan, the indoor fan motor assembly, the indoor coil thermistor, and the heat exchanger (Photo 20, 21, 22, 23, 24)

- (1) Remove the front panel, the horizontal vanes (upper R/L), (lower R/L), the corner boxes (R) (L), the panels (U) (R) (L), Wi-Fi assembly, the panel (F), the electrical box, the nozzle assembly and the air purifying device.
- (2) Loosen the screw inside the right side of the line flow fan (Photo 21).
- (3) Remove the 3 screws of the fan motor assembly. Pull the fan motor assembly slightly toward you, and remove it by pulling to the right (Photo 22).
- (4) Remove the indoor coil thermistor from the heat exchanger.
- (5) Remove the 2 screws of the hairpin holder on the left side of the heat exchanger. Raise the left side of the heat exchanger, and pull the line flow fan to the lower left to remove (Photo 23).
- (6) Disengage the 2 catches on the right side of the heat exchanger, and remove the heat exchanger (Photo 24).

* When attaching the line flow fan, screw the line flow fan so 4 mm gap is provided between the right end of the line flow fan and the right wall of the air passage of the box (Figure 3).

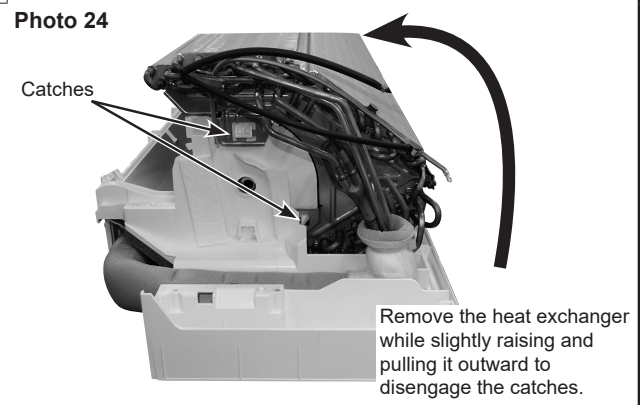
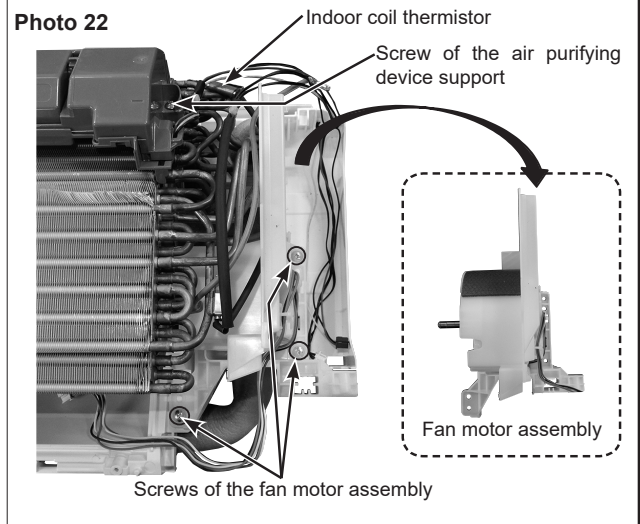
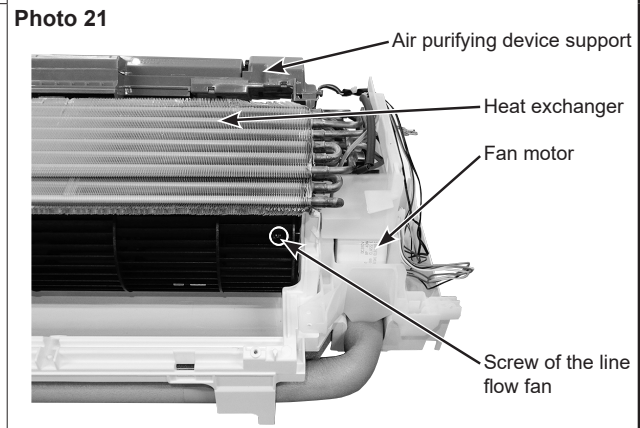
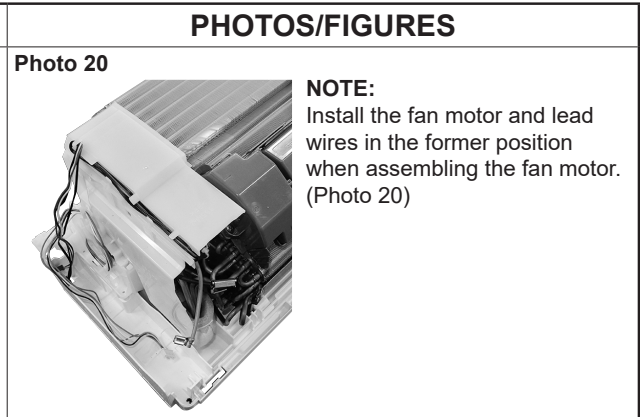
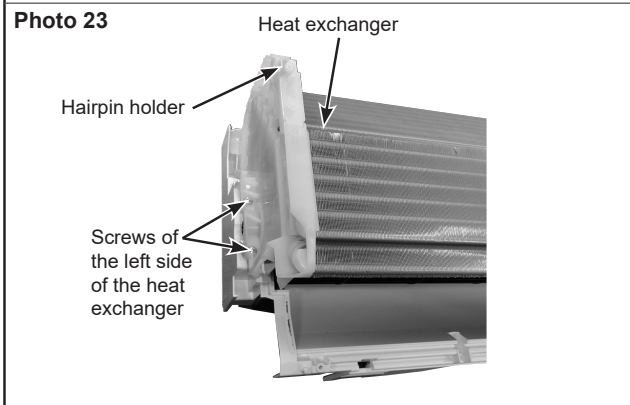

Fixing the indoor coil thermistor

*There are 2 forms of parts for fixing the indoor coil thermistor.

Clip shape



Holder shape



When fixing the indoor coil thermistor to the clip-shape/holder-shape part, the lead wire should point down.

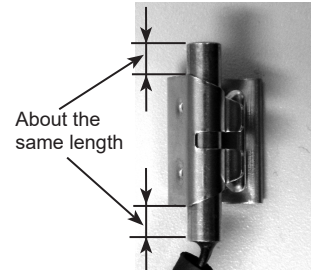

Position and procedure for mounting the clip-shape part

1. Set the indoor coil thermistor in the center of the clip-shape part.



2. Check the (marked) mounting position.



3. Mount the clip-shape part.



NOTE:

- Take care to avoid loss and accidental falling of the clip-shape part inside the unit.
- Mount the clip-shape part on the marked position.
- Do not pull the lead wire when removing the indoor coil thermistor.

mitsubishi **ELECTRIC CORPORATION**

HEAD OFFICE: TOKYO BUILDING, 2-7-3, MARUNOUCHI, CHIYODA-KU, TOKYO 100-8310, JAPAN